

# ALINCO

## WIDE RANGE SCANNING RECEIVER

# DJ-X10

## Instruction Manual

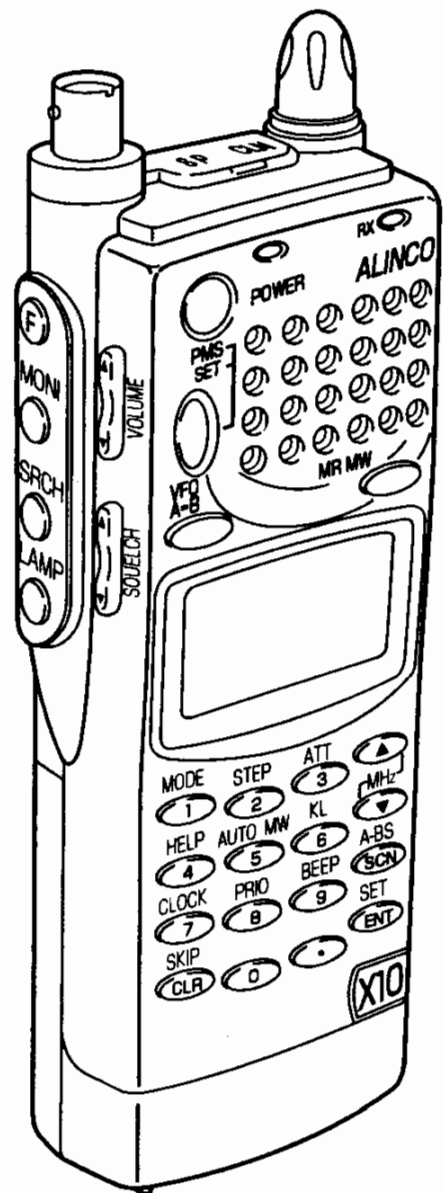

Thank you for buying the ALINCO receiver. The DJ-X10 instruction manual contains important safety and operating instructions. Read this manual carefully before using the product.

**For DJ-X10(T-version)**

**NOTE:** This equipment has been tested and found to comply with the limits for a Class B digital device, pursuant to part 15 of the FCC Rules. These limits are designed to provide reasonable protection against harmful interference in a residential installation. This equipment generates, uses, and can radiate radio frequency energy and, if not installed and used in accordance with the instruction manual, may cause harmful interference to radio communications. However, there is no guarantee that interference will not occur in a particular installation. If this equipment does cause harmful interference to radio or television reception, which can be determined by turning the equipment off and on, the user is encouraged to try to correct the interference by one or more of the following measures:

- Reorient or relocate the receiving antenna.
- Increase the separation between the equipment and receiver.
- Connect the equipment into an outlet on a circuit different from that to which the receiver is connected.
- Consult the dealer or an experienced radio/TV technician for help.

Specifications and information found in this document are subject to change without notice.

Copyright © 1997. All rights reserved. No part of this manual may be reproduced, copied, translated or transcribed in any form or by any means without the prior written permission of Alinco, Inc.

Names of products used in this manual are for identification purpose only and may be trademarks or registered trademarks of their respective company.

# Features

The Alinco DJ-X10 is a professional multifunctional receiver which covers a wide band of radio media from the low-frequency band (LF) to ultrahigh-frequency (UHF) band. It has the following features.

- |   |  |
|---|--|
| 1. Wide frequency range   | 0.1 ~ 1999.999950 MHz*   |
| 2. Basic modes  | Dual VFO, memory (MR), scan programming (PMS). One-touch switching.  |
| 3. Memory capacity  | 1200 CH (40 CH x 30 banks)   |
| 4. Scanning   | Programmable scanning (PMS)<br>Memory scan<br>Mode-selected scanning<br>VFO scan<br>VFO-linked scanning<br>Priority scan |
| 5. Allows programming of max. 20 scan programs.                 |  |
| 6. Channel scope  | Switchable between 40 and 7 CH.<br>Continuous search<br>Interval search<br>Peak search<br>Single search                  |
| 7. Battery-save function  |  |
| 8. Built-in clock   | 24-hour clock<br>ON timer<br>OFF timer   |
| 9. Built-in cable cloning function (Requires cable connection.) |  |
| 10. All mode reception  | AM/NFM/WFM/LSB/USB/CW/Auto   |
| 11. Channel step  | Selectable from 20 fixed steps (50 Hz ~ 500 kHz).  |
| 12. Frequency editing   |  |

\*DJ-X10T (U.S. version) cellular blocked.



# Contents

## Features Contents

How to read this manual .....	4
<b>1. Before use</b>	
1.1 Unpacking the receiver .....	5
1.2 Precautions in use .....	5
1.3 Names of parts and their functions .....	6
1.3.1 Top, front and left side panels .....	6
1.3.2 Rear and right panels .....	8
1.3.3 Display .....	9
1.3.4 Key pad .....	10
1.4 Setting up the DJ-X10.....	11
1.4.1 Attaching the antenna.....	11
1.4.2 Attaching the belt clip.....	11
1.4.3 Attaching the wrist strap .....	11
1.5 About the batteries .....	12
1.5.1 Attaching the battery pack .....	12
1.5.2 Loading batteries into the dry cell case .....	13
1.5.3 About the battery pack .....	14
1.5.4 Charging .....	15
1.5.5 Battery low alarm .....	15
<b>2. Basic operations</b>	
2.1 Turning the power ON/OFF.....	16
2.2 Setting the beginner's mode.....	17
2.3 Volume control .....	17
2.4 Squelch control .....	18
2.5 Setting frequency.....	18
2.6 Switching frequency band.....	19
2.7 Copying frequencies from one band to the other.....	20
2.8 Scanning.....	20
2.9 Searching (Channel Scope) .....	21
2.10 Monitoring (Squelch OFF).....	22
2.11 Turning backlight ON/OFF.....	22
2.12 Turning beep ON/OFF .....	23
2.13 Locking/Unlocking .....	23
2.14 Setting the clock .....	24
2.14.1 Displaying the current time.....	24
2.14.2 Setting the OFF timer .....	24
2.14.3 Setting the ON timer .....	25
2.14.4 Setting the current time.....	25
2.15 Basic modes .....	26
2.15.1 VFO mode.....	26
2.15.2 PMS mode .....	27
2.15.3 MR mode .....	27
2.16 Using HELP function.....	28

### 3. Expert's mode (Other Functions)

3.1	Setting the expert's mode	29
3.2	Functions common to all modes	30
3.2.1	Selecting the signal mode	30
3.2.2	Setting the frequency step	30
3.2.3	Attenuating interference from other channels (ATT)	31
3.2.4	Turning the priority function ON/OFF	31
3.2.5	Battery Save	32
3.2.6	Setting scan resume condition (SCAN MODE)	32
3.2.7	Setting scan signal level	33
3.2.8	Setting priority signal condition (PRI MODE)	34
3.2.9	Setting priority signal channel	35
3.2.10	Resetting the receiver	35
3.2.11	Setting search step (STEP ZOOM)	36
3.2.12	Setting search resume condition (SRCH MODE)	36
3.2.13	Copying data between two receivers (CLONE)	37
3.2.14	Controlling LCD contrast	38
3.2.15	Tuning in frequencies in the PMS/MR modes (M.TUNE)	39
3.2.16	Tuning in the peak signal among the Channel Scope display	39
3.3	VFO mode functions	40
3.3.1	Mode link between VFO-A and VFO-B (LINK SET)	40
3.3.2	Scanning between VFO's A and B (AB SCAN)	40
3.3.3	Copying frequencies from memories to the VFO	41
3.3.4	Copying frequencies from the PMS mode to the VFO	41
3.4	PMS mode functions	42
3.4.1	Programmed scan operations	42
3.4.2	Setting scan pass-frequency	43
3.4.3	Setting program link	43
3.4.4	Copying scan programs	44
3.4.5	Deleting scan programs	45
3.5	MR mode functions	46
3.5.1	Memorizing frequencies	46
3.5.2	Setting the Auto Memory Write	47
3.5.3	Setting memory scan skip	47
3.5.4	Setting memory scan radio system (MODE SEL)	48
3.5.5	Using the BANK LINK function	48
3.5.6	Setting memory scan channels (P.MR SETUP)	49
3.5.7	Scanning only memory channels set in P.MR SETUP	50
3.5.8	Copying memory banks	50
3.5.9	Copying memory channels	51
3.5.10	Deleting memory banks	52
3.5.11	Deleting memory channels	53

### 4. Appendix

4.1	Specifications	54
4.2	Troubleshooting	55
4.3	Options	55
4.4	Help function list	56
4.5	Menu tree	57
4.6	Index by key words	58

# How to read this manual

The following typographical and graphic conventions are used in this instruction manual.

**Bold typeface** indicates titles of chapters and sections as well as messages shown on the display.

When used to indicate displayed messages, only the part of the message that is pertinent to the explanation is given. Actual messages may however contain more characters.

Plain typeface text enclosed in " " indicates sections in this instruction manual you should refer to for further information. Only in a few cases are quotation marks used to identify terminology.



**CAUTION**

*The caution icon contains information which, if ignored or not followed correctly, could result in product damage. Always read and observe these items.*



**Note**

*The note icon contains additional information pertinent to product use, which is helpful but not necessarily known.*

# 1. Before use

## 1.1 Unpacking the receiver

The DJ-X10 should come with the following accessories. Check that nothing is missing when you first open the package.

- Antenna × 1
- Charger × 1
- EBP-37N (Ni-Cd battery pack ) × 1
- Belt clip × 1
- Belt clip screws × 2
- Wrist strap × 1
- DJ-X10 Instruction Manual (This manual) × 1

Standard accessories may differ depending on the version.

## 1.2 Precautions in use

- Do not disassemble the battery case or touch internal parts. Unauthorized handling could result in accident and/or product damage.
- Do not use or store the receiver in dusty places, under direct sunlight, near to sources of heat, or in other adverse environments.
- Attach the included antenna securely to the receiver.
- Use only the EDC-36 (car lighter cable with active filter) to draw power from an automobile.
- If the receiver emits smoke or strange odors, shut power OFF immediately and promptly contact an authorized dealer.
- Do not disassemble or tamper with the receiver. The DJ-X10 is not warranted for troubles or accidents resulting from unauthorized modifications, regardless of the warranty period. Alinco dealer also reserves the right to refuse to service the receiver in such event.
- Obtain approval from the proper authorities before using this receiver onboard aircraft or in hospitals.
- Do not use 6 V or higher voltage batteries (e.g. EBP-35N, EBP-36N).

# 1.3 Names of parts and their functions

This section describes parts by name and function.

## 1.3.1 Top, front and left side panels

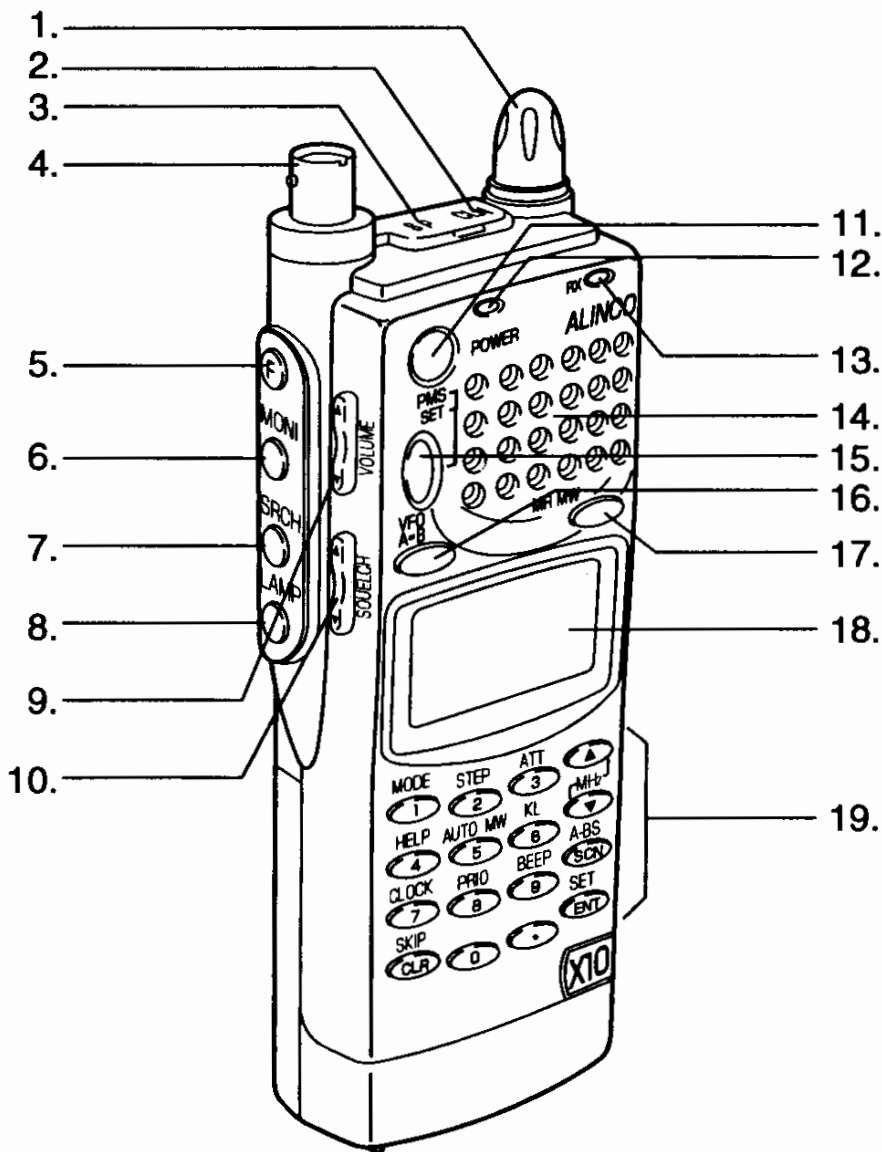

- |                             |   |
|-----------------------------|---|
| <b>1. Dial</b>              | Use to switch frequency and memory channel, and to make other settings.                 |
| <b>2. CLN terminal</b>      | Use to clone settings between similar receivers, and to communicate with the PC editor. |
| <b>3. SP terminal</b>       | Connect an external speaker or earphone here.   |
| <b>4. Antenna connector</b> | BNC connector. Attach the included antenna here.  |



5. **Ⓢ (Function) key** Use this key in combination with other keys to call up specific functions.
6. **MON key** Temporarily cancels the squelch for the duration it is held down. Used independent of squelch level.
7. **SCN key** Press to start scanning within a 40-channel range. Press again to cancel the scan. If pressed in combination with the Ⓢ key, scanning stays within a 7-channel range.
8. **LAMP** Turns the key backlight ON/OFF.
9. **VOLUME ▲/▼ keys** Use to adjust speaker volume.
10. **SQUELCH ▲/▼ keys** Use to adjust squelch sensitivity, the level at which noise is muted.
11. **POWER switch** Turns power ON/OFF.
12. **Hardware reset key** Press to reset all functions to their factory-settings. Data stored in memory is not deleted.
13. **Busy lamp** Lights up when a signal is picked up and stays lit while the signal is alive.
14. **Speaker** Sound is produced from here.
15. **PMS/BST key** Shifts to the scan programming mode. If pressed in combination with the Ⓢ key, the scan programs can be saved in memory. Press for 1 sec. for PMS setting.
16. **VFO key** Engages the dual VFO mode. If pressed in combination with the Ⓢ key, the frequency displayed in the top band is copied in the bottom band.
17. **MR/MW key** Use to access the memory. If pressed in combination with the Ⓢ key, frequencies and other data can be saved in memory. Press for 1 sec. for MR setting.
18. **Display** Displays frequency, operating status and other information pertinent to use.
19. **Key pad** In the VFO mode, use these keys to directly input the frequency you want. Press in combination with the Ⓢ key to access other functions.

## 1.3.2 Rear and right panels

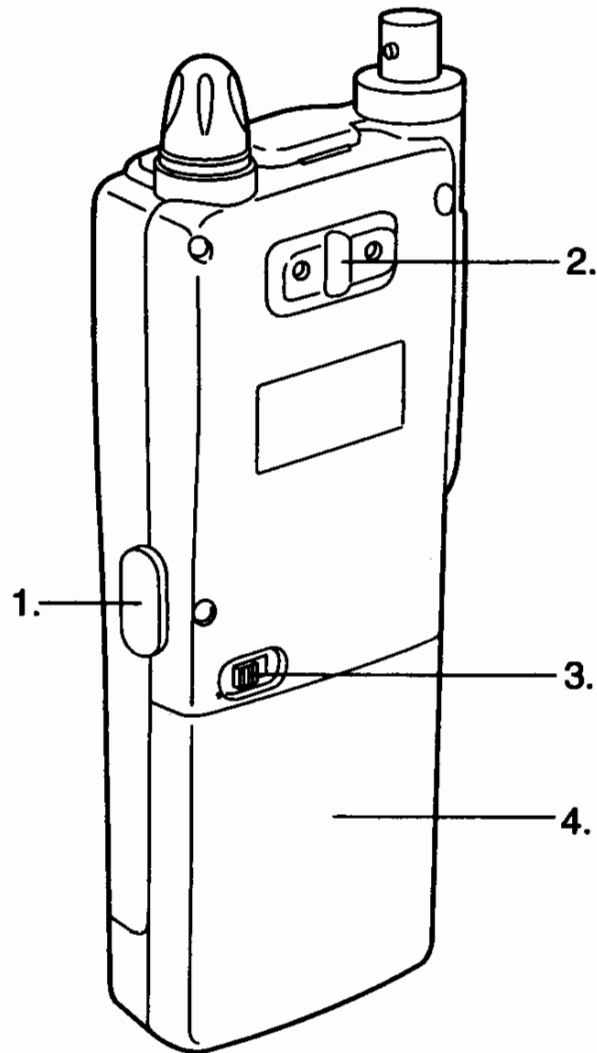





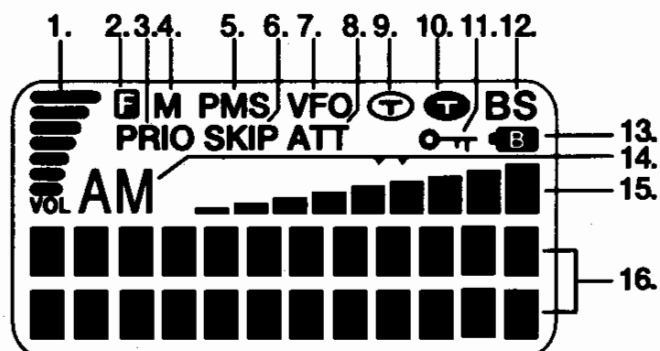

























- 1. DC-IN**                      Connect an external DC supply here (8 ~ 15 V).
- 2. Holes for attaching belt clip**                      Screw the included belt clip to the DJ-X10 here.
- 3. Battery case lock**                      Slide to the right to detach the battery case.
- 4. EBP-37N battery pack or dry cell case**                      The dry cell case can hold four AA batteries.

## 1.3.3 Display



- |                               |  |
|-------------------------------|--|
| 1.                            | Meter for displaying sound level.  |
| 2.                            | Displayed when the  key has been pressed to indicate that you can access the subfunctions of the keys. |
| 3. <b>PRIO</b>                | Displayed while the priority function is ON.   |
| 4. <b>M</b>                   | Displayed in the MR mode.  |
| 5. <b>PMS</b>                 | Displayed in the PMS mode.   |
| 6. <b>SKIP</b>                | Displayed for memory channels which are skipped in memory scans. Skip is user-set.                     |
| 7. <b>VFO</b>                 | Displayed in the VFO mode.   |
| 8. <b>ATT</b>                 | Displayed when the attenuator is ON.   |
| 9.                            | Displayed when the ON timer has been set.  |
| 10.                           | Displayed when the OFF timer has been set.   |
| 11.                           | Displayed while keys are locked.   |
| 12. <b>BS</b>                 | Displayed when the battery-save function is ON.  |
| 13.                           | Displayed when battery power is low. Promptly replace the batteries if this icon is displayed.         |
| 14. <b>AM</b>                 | Mode is displayed.   |
| 15. <b>S-meter</b>            | S-meter. Depending on settings, the time or the channel scope setting is also displayed here.          |
| 16. <b>Dot-matrix display</b> | This is where band, channel name and frequency are displayed in the various modes.                     |

## 1.3.4 Key pad

1.  Inputs **1**. Press in combination with the  key to switch the mode.
2.  Inputs **2**. Press in combination with the  key to set frequency step.
3.  Inputs **3**. Press in combination with the  key to turn the attenuator ON/OFF.
4.  Inputs **4**. Press in combination with the  key for help.
5.  Inputs **5**. Press in combination with the  key to turn the auto memory write function ON/OFF.
6.  Inputs **6**. Press in combination with the  key to lock/unlock keys.
7.  Inputs **7**. Press in combination with the  key to turn the clock display ON/OFF and set timers.
8.  Inputs **8**. Press in combination with the  key to turn the priority function ON/OFF.
9.  Inputs **9**. Press in combination with the  key to turn the beep ON/OFF.
10.  Clears setting. In the PMS and MR modes, press in combination with the  key to set the scan pass frequencies and skip channels.
11.  Inputs **0**.
12.  Inputs **•**. Used for link setting and PMS/MR bank selection.
13.  Increases the frequency in the set frequency steps. Also, increases memory channel No. and switches the scan to the upward direction. Press in combination with the  key to increase the frequency in 1 MHz steps.
14.  Decreases the frequency in the set frequency steps. Also, decreases memory channel No. and switches the scan to the downward direction. Press in combination with the  key to decrease the frequency in 1 MHz steps.
15.  Starts scanning. Press in combination with the  key to scan between band A and band B.
16.  Calls up menus and enters input values. Press in combination with the  key to set user level and to turn the battery-save function ON/OFF.

## 1.4 Setting up the DJ-X10

Before using your receiver, attach the included antenna securely. If wanting to use the belt clip or wrist strap, attach them too.

### 1.4.1 Attaching the antenna

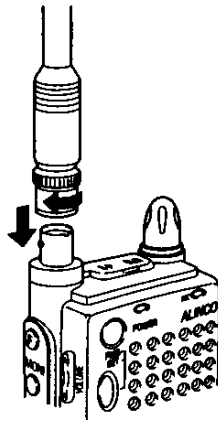

Fit the base of the antenna over the projections on the connector, press downward and turn clockwise. Check that antenna is securely attached.

### 1.4.2 Attaching the belt clip

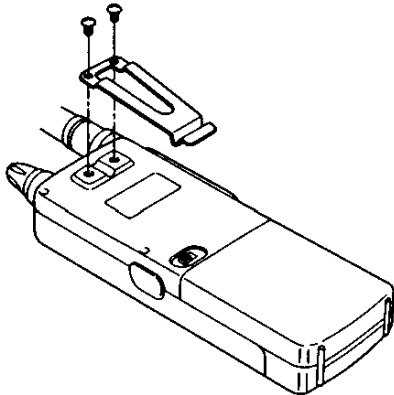

Screw the belt clip onto the rear panel (screws x 2). Check the clip is securely attached before use.

### 1.4.3 Attaching the wrist strap

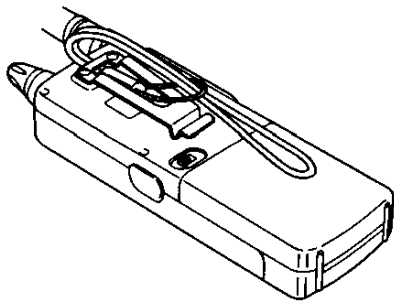

Fit the wrist strap under the belt clip and pull it through its own loop.



# 1.5 About the batteries

## 1.5.1 Attaching the battery pack

- To detach the battery pack

Slide the battery latch on the back to the right and pull the case downward to detach.

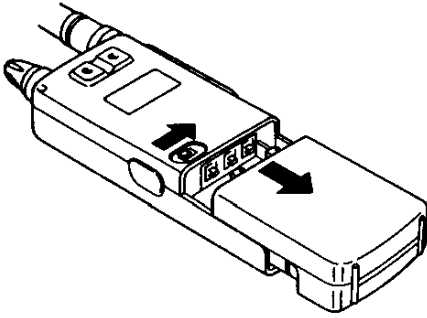

- To attach the battery pack

Fit the battery pack into the holes on the DJ-X10 and push in the direction of the arrow until the case snaps into the place.

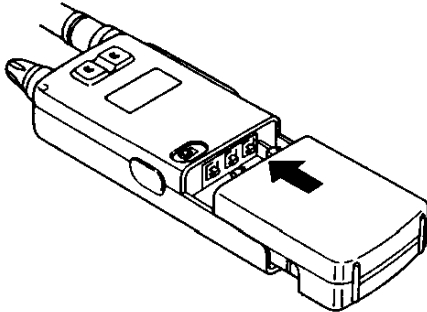

## 1.5.2 Loading batteries into the dry cell case

### 1. Open the dry cell case.

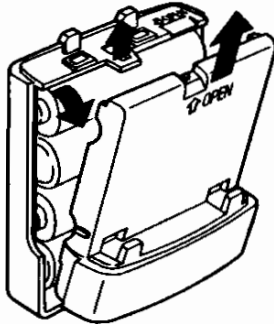

Pull the tab on the top of the case upwards to loosen the latch.

Open the inner-side case outwards and up to detach.

### 2. Load the batteries.

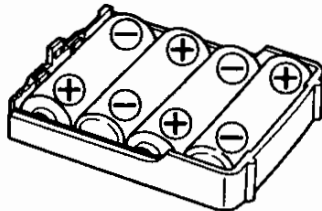

Load four AA alkaline batteries into the case with the + and - ends facing in the assigned directions indicated by the relief inside the case.

### 3. Reattach the cover.

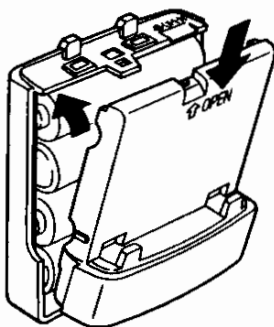

Fit the bottom of the case first, then close the case until the latch snaps into the place.



**CAUTION:**

- Use only batteries of the same brand. For longer use, we recommend using alkaline batteries.
- Do not mix old and new batteries.
- Before using an optional Ni-Cd battery pack, read the instructions that come with the battery pack.

## 1.5.3 About the battery pack

Before using the included EBP-37N battery pack, please note the followings.

1. The battery pack is not charged before it is shipped from the factory.  
Charge the pack before using the DJ-X10 for the first time.
2. Approximately 11 hours are required to fully charge the battery pack with the charger.
3. Charge batteries only in temperatures from 0°C to 40°C (32°F~104°F).
4. DANGER! Do not disassemble, tamper with, heat or wet the battery pack.
5. Do not short-circuit battery pack terminals. This can generate heat inside the pack resulting in burns and/or damage to the pack.
6. Do not overcharge the battery pack. Overcharging can lead to battery performance loss.
7. Store the battery pack in a cool, dry place where temperature is between -20°C and 45°C (-4°F~113°F). Environments outside this range can cause battery acid to leak and metal parts to rust.
8. The battery pack can be fully recharged approximately 300 times. When a fully charged battery pack lasts considerably less than expected, it is time to replace it with a fresh pack.
9. Do not throw away dead Ni-Cd battery packs. They can be recycled. Give them to stores which accept old batteries.
10. This battery pack can be recharged while mounted on the DJ-X10, by connecting an 8 ~ 15 V power supply (negative ground) to the DC-IN terminal.



Ni-Cd

### • To prevent battery pack from short-circuiting

When carrying the battery pack, be extremely careful not to short-circuit the terminals. If short-circuited, the high surge in current could heat up the pack, resulting in burns or fire.

1. Keep the battery pack away from metal objects such as necklaces, etc.
2. Do not keep the battery pack inside bags with metal-plated linings or wrap it in handkerchiefs with metallic thread or print.
3. Do not leave the battery pack in proximity of electro-conductive materials or metal objects such as nails or chains.
4. Place the battery pack in an electrically-insulated bag or wrap it in a handkerchief before putting it in your handbag, etc.
5. Place the battery pack on an electrically-insulated mat when setting it on a flat surface.



## 1.5.4 Charging

Use only the included EDC-63/64 or optional EDC-60/61 charger to recharge the Ni-Cd battery pack. Also, before charging the Ni-Cd battery pack for the first time, note the following.

### • How to charge

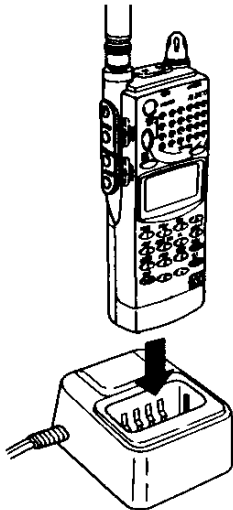

Fit the Ni-Cd battery pack into the ribs on both sides of the charger and slide it into place. Once in place, charging will start automatically. The CHARGE lamp is lit while charging the pack.



### CAUTION

- While charging the battery pack, turn OFF the power.
- Never use the EDC-63/64 charger to charge radios of other types.
- The time required to charge the Ni-Cd battery will vary depending on how much power has been drained as well as the type of battery pack used. For details, see the instructions that came with the Ni-Cd battery pack.
- Be careful not to short-circuit the charging terminals on the Ni-Cd battery pack with paper clips, etc. This can damage the battery pack.

### • Rechargeable battery packs

The following Ni-Cd battery packs can be recharged with the EDC-63/64/60/61 charger.

EBP-33N (4.8 V, 650 mAH)

EBP-34N (4.8 V, 1200 mAH)

EBP-37N (4.8 V, 700 mAH)

## 1.5.5 Battery low alarm

When batteries get low, the  icon appears on the display to the sound of a repeated siren-like alarm. Change the batteries as soon as possible.

The alarm will not be emitted if the beep is turned OFF.



## 2. Basic operations

The DJ-X10 has the beginner's mode and the expert's mode. As its name suggests, the beginner's mode is for persons who are using the DJ-X10 for the first time. Keys are used within a limited scope and essential high performance operations are performed. The expert's mode uses keys in more selectable manner, and the user can utilize top notch features of the DJ-X10. For the expert's mode, see "3. Expert's mode (Other Functions)" on page 29.

This chapter explains operations in the beginner's mode. It should help you familiarize yourself with how the DJ-X10 works and is used.

### 2.1 Turning the power ON/OFF

Power to the DJ-X10 is turned ON/OFF as follows.

- **Power ON**

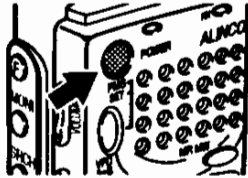

Hold down the POWER switch for about 1 second until the initial message appears on the display.

- **Power OFF**

Hold down the POWER switch until the display goes out.

## 2.2 Setting the beginner's mode

The beginner's mode is set as follows. By default, the DJ-X10 starts in the beginner's mode.

### 1. Call up the USER LEVEL menu.

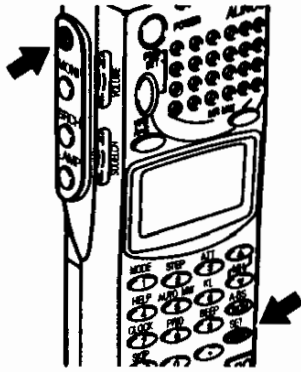

Press the **F** key to display **F**, followed by the **MENU** key. This will display the CONFIG menu. Using the dial or the **MENU** / **MENU** keys, move the arrow to **USER LEVEL**, then press the **MENU** key again.



### 2. Select the beginner's mode.

Move the arrow to **Beginner** using the dial or the **MENU** / **MENU** keys, then press the **MENU** key.

The display will return to the CONFIG menu; select **END** using the dial or the **MENU** / **MENU** keys, then press the **MENU** key. This completes the setting.



## 2.3 Volume control

Volume is set as follows.

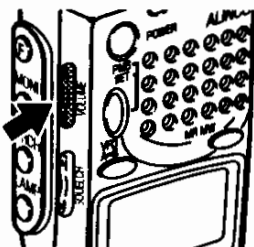

To increase speaker volume, press the upper part of the **VOLUME** **▲** key. To decrease it, press the lower part the **VOLUME** **▼** key. The **■** bars on the display will increase/decrease as you change the volume.



**Note:** To disengage the squelch (the mute function) temporarily, press and hold the **MENU** key on the left panel. This will enable you to set the volume setting without changing the squelch setting (see "2.4 Squelch control" on page 18).

## 2.4 Squelch control

Squelch is used to mute the speaker noise when no signal is being received. Squelch level can be selected between SQ0 and SQ9. Setting is made as follows.

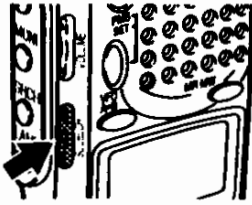

To mute the noise, press the upper part of the SQUELCH  $\blacktriangle$  key. To unmute the noise, press the lower part of the SQUELCH  $\blacktriangledown$  key. The displayed level will change as you adjust the squelch level.

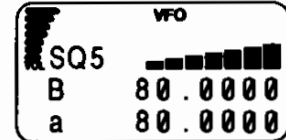

- Note:**
- Noise is gradually muted as the squelch level goes from SQ0 to SQ9. Using the SQUELCH  $\blacktriangle$  key, set the squelch to a level at which the noise just disappears.
  - If the squelch set is too high, weak incoming signals may not be heard from the speaker.

## 2.5 Setting frequency

Frequency can be set in any of three ways: By using the numeric keys, the  $\blacktriangle$  /  $\blacktriangledown$  keys, or the dial.

### • Setting by numeric keys

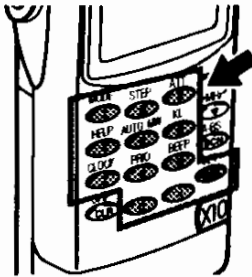

Input the frequency directly from the numeric keys and then press the  $\text{SET/ENT}$  key.

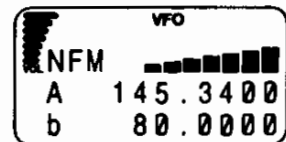





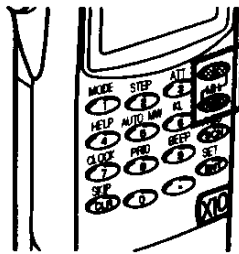

**Example 1** To set 145.3400 MHz, press the  $\text{MODE}$   $\text{1}$ ,  $\text{HELP}$   $\text{4}$ ,  $\text{AUTO MW}$   $\text{5}$ ,  $\text{ATT}$   $\text{3}$ ,  $\text{HELP}$   $\text{4}$  and  $\text{SET/ENT}$  keys in the given order. The **00** on the end can be omitted.

**Example 2** To set 0.5580 MHz (that is, 558 kHz), press the  $\text{0}$ ,  $\text{AUTO MW}$   $\text{5}$ ,  $\text{AUTO MW}$   $\text{5}$ ,  $\text{PRIO}$   $\text{8}$  and  $\text{SET/ENT}$  keys in the given order. The **0** on the end can be omitted.

• Setting with the  /  keys



For higher frequencies, press the  key. For lower frequencies, press the  key. Frequency will increase/decrease in the set frequency steps.



To increase/decrease frequency in 1MHz steps, press the  key to display  and press the  /  keys.

 *Note:* To change frequency step, see "3.2.2 Setting the frequency step" on page 30.

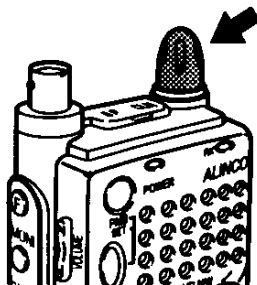
• Setting from the dial



For higher frequencies, turn the dial clockwise. For lower frequencies, turn it counter-clockwise. Frequency will increase/decrease in the set frequency steps.

To increase/decrease frequency in 10MHz steps, press the  key to display  and turn the dial to increase/decrease the displayed frequency.

 *Note:* To change frequency step, see "3.2.2 Setting the frequency step" on page 30.

## 2.6 Switching frequency band

The DJ-X10 uses a dual VFO system, so that a frequency change can be done smoothly by inputting a new frequency on the second band in advance. The frequency currently being monitored is displayed next to the capital letter on the top line of the display. Frequency band can be switched as follows.

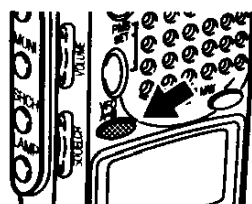

Press the  key. The frequencies on the top and bottom lines will switch places, with the letters changing between capital and lower case.

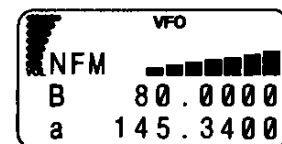

## 2.7 Copying frequencies from one band to the other

The frequency on the currently used band can be copied into the other band as follows.

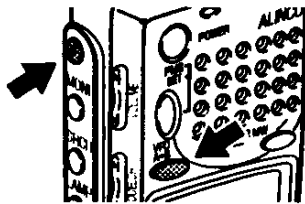

Press the **F** key to display **F**, followed by the **COPY** key.

This will copy the frequency on the currently used band (displayed on top line next to capital letter) into the other band (displayed on bottom line next to small case letter).

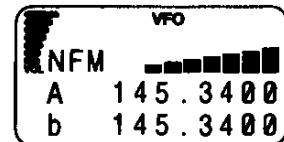

## 2.8 Scanning

Scanning is used to locate frequencies with signals present. Basic scanning operations are as follows.

### • To scan

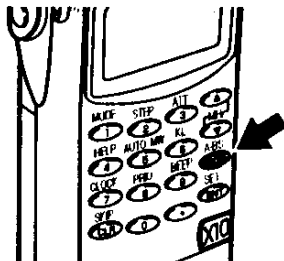

Press the **A-B/BCN** key. Scanning will start and will proceed in the set frequency steps.

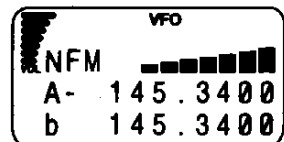

While scanning, an arrow icon is displayed next to the frequency on currently used band (displayed on top line next to capital letter). The arrow points to the left while scanning towards the higher frequencies. When the DJ-X10 locates a frequency with a signal, it pauses temporarily and tunes it in. To resume scanning, either turn the dial or press either of the **▲/MFC** / **▼/MFC** keys. Scanning resumes automatically without any operation depending on the scan setting (see "3.2.6 Setting scan resume condition (SCAN MODE)" on page 32).

### • To switch scanning direction

While scanning, press the **▼/MFC** key. The arrow icon will face right and scanning will proceed towards the lower frequencies. To scan towards the higher frequencies, press the **▲/MFC** key. Scan direction can also be changed by turning the dial in the opposite direction.

### • To cancel scanning

Press the **A-B/BCN** key again.

## 2.9 Searching (Channel Scope)

The search function, or Channel Scope of the DJ-X10 checks frequencies in the set frequency steps, and displays signals within a 40-channel or 7-channel range at one time. The function is useful for checking the spectrum occupancy at a glance. It is used as follows.

### • 40-channel search

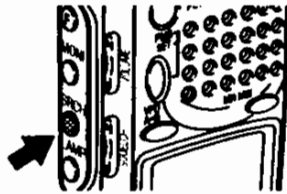

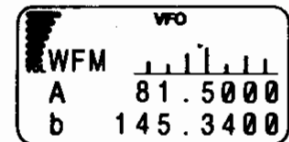

Press the  key on the left side panel. The DJ-X10 will start searching for signals within a 40-channel range of the currently received frequency. The search proceeds in the set frequency steps with the displayed frequency in the center under ▼ mark. The higher channel spectra are displayed towards the right, and the lower to the left. Vertical length of each spectrum indicates strength of the signals.

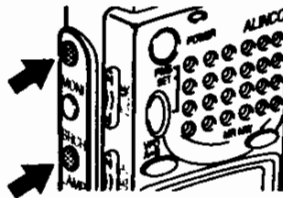

### • 7-channel search





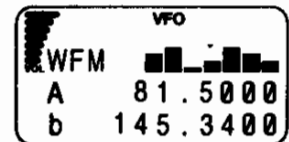

Press the  key to display . Then, press the  key on the left side panel. The DJ-X10 will start searching for signals within a 7-channel range of the currently received frequency. The search proceeds in the set frequency steps with the displayed frequency in the center under ▼ mark. The higher channel spectra are displayed towards the right, and the lower to the left. Vertical length of each spectrum indicates strength of the signals.



### • To tune in live frequencies



Turn the dial or press the  /  keys to bring the frequency to center. Turning the dial clockwise or pressing the  key moves the display to the left. Turning the dial counter-clockwise or pressing the  key moves the display to the right.

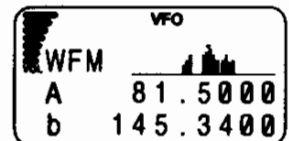

### • To cancel the search

Press the  key again. This will cancel the search.





- Note:
- To set search step and search resume condition, see "3.2.11 Setting search step (STEP ZOOM)" and "3.2.12 Setting search resume condition (SRCH MODE)" on page 36.
  - The search resume condition factory-setting is **INTERVAL**. Sound is muted during the search. The search operation is performed every 10 seconds.

## 2.10 Monitoring (Squelch OFF)

The monitor function is used to pick up weak signals .

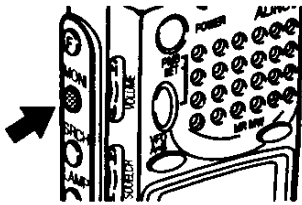
- To turn the monitor ON





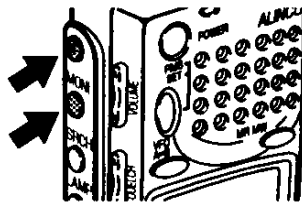

Hold down the  key. The duration the key is depressed, the squelch is turned OFF and weak signals can be picked up . (Noise is heard if no signal is being received.)

When the  key is released, the squelch comes back ON and the DJ-X10 returns to its original state.

- To keep the monitor ON at all times





Press the  key to display  , followed by the  key. The squelch will remain OFF even after the  key has been released. Pressing the  key a second time will reactivate the squelch.

## 2.11 Turning backlight ON/OFF

The DJ-X10 has a backlight to make it easier to use at night. The backlight can be turned ON/OFF as follows.

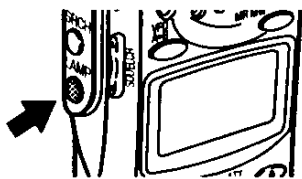



- To turn the backlight ON

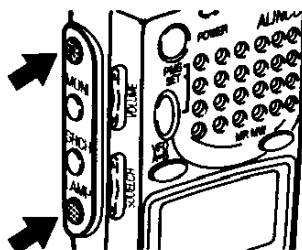

Press the  key. The display will be lit while operating the dial or keys. Keys also light up when pressed or held down. The backlight goes OFF automatically if the controls are not used for approximately 5 seconds.

- To leave the backlight ON at all times



Press the  key to display  , followed by the  key. The backlight will remain ON until you press the  key again.



## 2.12 Turning beep ON/OFF

The DJ-X10 emits long or short-long beeps when keys are pressed or other operations are performed. The beep can be turned ON/OFF as follows.

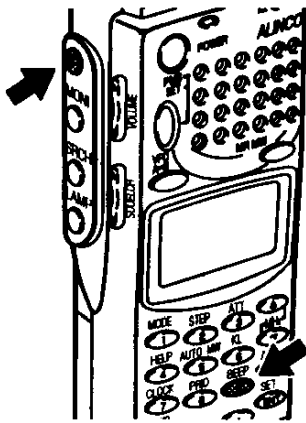

Press the  $\text{F}$  key to display  $\text{F}$ , followed by the  $\text{BEEP}$  key.

This will display the BEEP setting.

Then, move the arrow to either **ON**

or **OFF** as desired, using the dial or the  $\text{▲}$  /  $\text{▼}$  keys.

Then, press the  $\text{SET/ENT}$  key. When set to **ON**, the beep is heard.



## 2.13 Locking/Unlocking

This feature locks all but certain keys, preventing accidental operation of the keys. Keys can be locked/unlocked as follows.

### • To lock keys

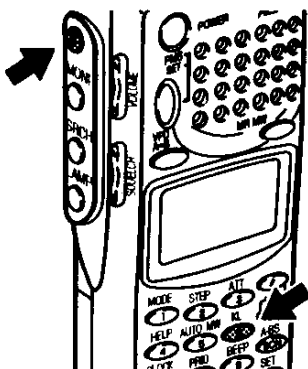

Press the  $\text{F}$  key to display  $\text{F}$ , followed by the  $\text{LOCK}$  key.

The  $\text{🔒}$  icon will appear on the display. Key inputs are not

accepted except for the  $\text{POWER}$ ,  $\text{MONI}$ ,  $\text{VOLUME}$   $\text{▲}$ / $\text{▼}$ ,  $\text{SQUELCH}$   $\text{▲}$ / $\text{▼}$ ,  $\text{F}$  and  $\text{LAMP}$  keys.

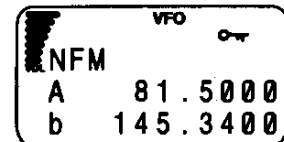

### • To unlock keys

Again, press the  $\text{F}$  key to display  $\text{F}$ , followed by the  $\text{LOCK}$  key. This will unlock the keys.

## 2.14 Setting the clock

The following procedures explain how to display the current time and how to set power ON/OFF timers and the current time.

### 2.14.1 Displaying the current time

#### 1. Call up the TIME menu.

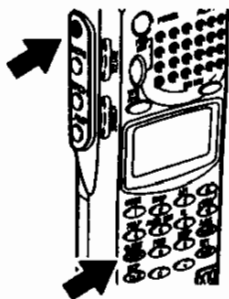

Press the **F** key to display **F**, followed by the **CLOCK 7** key. This will display the TIME menu. Then, move the arrow to **DISP TIME** using the dial or the **▲ MHz** / **▼ MHz** keys, and press the **SET ENT** key. This will display the DISP TIME menu.



#### 2. Turn the time display ON/OFF.

Move the arrow to **ON** or **OFF**, using the dial or the **▲ MHz** / **▼ MHz** keys. Then, press the **SET ENT** key. When set to **ON**, the time is displayed, as opposed to not when set to **OFF**.



The display will return to the TIME menu, so move the arrow to **END** using the dial or the **▲ MHz** / **▼ MHz** keys, and then press the **SET ENT** key. This completes the setting.

### 2.14.2 Setting the OFF timer

#### 1. Call up the OFF TIMER setting.

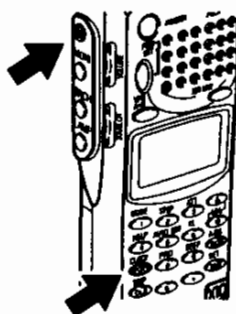

Press the **F** key to display **F**, followed by the **CLOCK 7** key. This will display the TIME menu. Then, move the arrow to **OFF TIMER** using the dial or the **▲ MHz** / **▼ MHz** keys, and press the **SET ENT** key. This will display the OFF TIMER setting. (If nothing has been previously set, **\*\* : \*\*** will be displayed. Otherwise, the set time will appear.)



#### 2. Set the OFF timer.

Move the cursor to select hours and minutes digits using the **▲ MHz** / **▼ MHz** keys, and set the time you want the power to turn OFF, using the dial. Minutes are set in the 00 ~ 59 range, and hours are set in the 00 ~ 23 range. (To clear the setting, press the **SKIP CLR** key.) Once the setting has been made, press the **SET ENT** key. The display will return to the TIME menu; move the arrow to **END** using the dial or the **▲ MHz** / **▼ MHz** keys, then press the **SET ENT** key. This completes the setting.

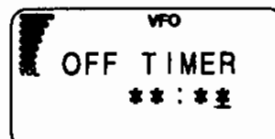

## 2.14.3 Setting the ON timer

### 1. Call up the ON TIMER setting.

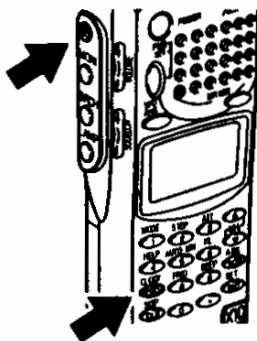

Press the **TIME** key to display **TIME**, followed by the **CLOCK 7** key. This will display the TIME menu. Then, move the arrow to **ON TIMER** using the dial or the **▲** / **▼** keys, and press the **SET ENT** key. This will display the ON TIMER setting. (If nothing has been previously set, **\*\* : \*\*** will be displayed. Otherwise, the set time will appear.)

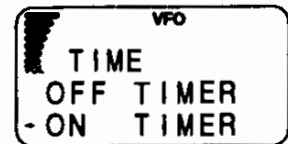

### 2. Set the ON timer.

Move the cursor to select hours and minutes digits using the **▲** / **▼** keys, and set the time you want the power to turn ON, using the dial. Minutes are set in the 00 ~ 59 range, and hours are set in the 00 ~ 23 range. (To clear the setting, press the **CLR** key.) Once the setting has been made, press the **SET ENT** key.

The display will return to the TIME menu; move the arrow to **END** using the dial or the **▲** / **▼** keys, then press the **SET ENT** key. This completes the setting.

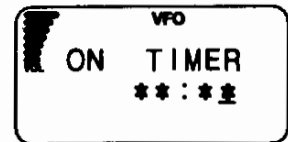

## 2.14.4 Setting the current time

### 1. Call up the NOW TIME setting.

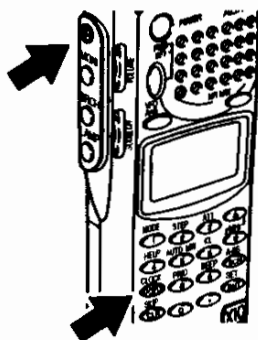

Press the **TIME** key to display **TIME**, followed by the **CLOCK 7** key. This will display the TIME menu. Move the arrow to **NOW TIME** using the dial or the **▲** / **▼** keys. Then, press the **SET ENT** key. This will display the NOW TIME setting. (If nothing has been previously set, **\*\* : \*\*** will be displayed. Otherwise, the set time will appear.)



### 2. Set the current time.

Move the cursor to select hours and minutes digits using the **▲** / **▼** keys, and set the current time, using the dial. Minutes are set in the 00 ~ 59 range, and hours are set in the 00 ~ 23 range. (To clear the setting, press the **CLR** key.) Once the setting has been made, press the **SET ENT** key.

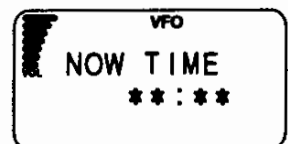

The display will return to the TIME menu; move the arrow to **END** using the dial or the **▲** / **▼** keys, then press the **SET ENT** key. This completes the setting.



## 2.15 Basic modes

The DJ-X10 has three basic modes: VFO, PMS, and MR. The current mode is displayed along the top of the display.

- **VFO mode**

This mode is for tuning in frequencies using the dial or  /  keys. This mode is the factory-setting that appears when power is turned ON for the first time.

- **PMS (programmed scan-range) mode**

This mode is for tuning in selected channels within a set scan range.

- **MR (memory) mode**



This mode is for saving often used frequencies in memory. The frequencies can then be retrieved and tuned in.

### 2.15.1 VFO mode

The VFO mode has two bands: A and B.

- **To enter the VFO mode**



Press the  key. This will engage the VFO mode. (If the VFO mode is already engaged, pressing the  key will switch between bands A and B.)

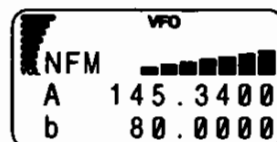

To tune in frequencies or switch bands, see "2.5 Setting frequency" on page 18 and "2.6 Switching frequency band" on page 19.

## 2.15.2 PMS mode

The PMS mode has a total of 20 programmable bands, 10 each for the capital P and lower case p.

### 1. Enter the PMS mode.



Press the  key. This will engage the PMS mode. Then, select a registered band and start scanning. Bands are preregistered before the DJ-X10 is shipped from the factory, but they can be changed in the expert's mode. (See "3.4.1 Programmed scan operations" on page 42.)

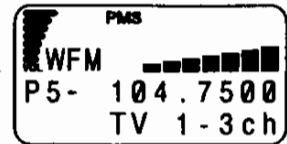

### 2. Select between P and p.

Press the  key to switch back and forth between the capital P and the lower case p.

### 3. Select a bank.

Press the numeric key for the bank you want. The corresponding scan program will begin when you make your selection.

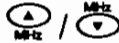
Scanning direction can be changed using the dial or the  keys.

Pressing a different numeric key will start scanning under that bank instantly.

## 2.15.3 MR mode

The memory mode has three bank groups: A, B and C. Each group has 10 banks (0~9) where each bank can hold up to 40 channels (00~39), for a total of 1200 channels.

### 1. Enter the MR mode.

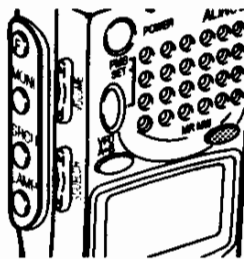

Press the  key. This will engage the MR mode and will display registered frequencies and names.

Frequencies are preregistered before the DJ-X10 is shipped from the factory, but they can be changed in the expert's mode. (See "3.5.1 Memorizing frequencies" on page 46.)

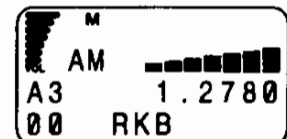

### 2. Select the memory bank group.

Press the  key to switch between memory bank groups A, B and C.

### 3. Select a bank.

Press the numeric keys for the bank No. you want in the selected group.

### 4. Set a channel.



Select a channel between 00 ~ 39, using the dial or the  keys. The frequency saved in that channel will be displayed on the top line, while its name will appear on the bottom line of the display.

## 2.16 Using HELP function

The HELP function lets you check which keys you need to press to perform specific operations. The information is shown on the display. It is useful when you are unsure what to do. See the Help Function Table at the end of this manual.

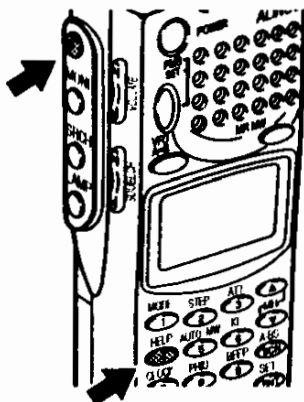



### 1. Get the HELP menu.



Press the  key to display , followed by the  key. This will display the HELP menu.



### 2. Select a specific function.

Move the arrow to the function you want to check, using the dial or the  /  keys. Then, press the  key. This will display a submenu; similarly select the specific function you want to check, and press the  key again. (Some items do not have submenus.)

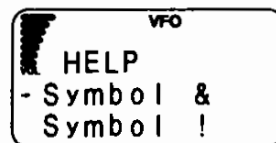









A simple symbolic explanation of the operation will be shown on the display. For more information, see the reference page given in the "4.4 Help function list" on page 56 of this manual.

### 3. Exit the help function.

Press the  key until returning to the original display.



*Note: If the display is in Japanese, press the  key to display , followed by the  key. Then, move the arrow to **LANGUAGE** using the dial or the  /  keys, and press the  key again. Then, move the arrow as before to **ENGLISH** and press the  key. After that, move the arrow to **END** and press the  key.*

# 3. Expert's mode (Other Functions)

The expert's mode allows the user to customize the functions to suit best for desired operation. This mode is for those users familiar with the beginner's mode (see "2 Basic operations" on page 16).

Certain features of DJ-X10 are available only in the expert's mode. This chapter explains these features in each of the DJ-X10's basic modes. Please review the basic operations and features before moving on to its advanced features.

## 3.1 Setting the expert's mode

The expert's mode is set as follows. The initial setting is the beginner's mode.

### 1. Call up the USER LEVEL menu.

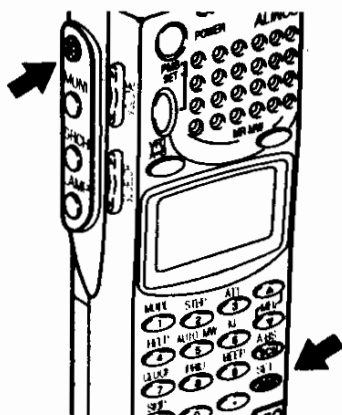

Press the  $\text{MENU}$  to display  $\text{F}$ , followed by the  $\text{SET/ENT}$  key. This will display the CONFIG menu. Move the arrow to **USER LEVEL** using the dial or the

$\text{UP}/\text{MHz}$  /  $\text{DOWN}/\text{MHz}$  keys, then press the  $\text{SET/ENT}$  key.



### 2. Set the expert's mode.

Move the arrow to **Expert** using the dial or the  $\text{UP}/\text{MHz}$  /  $\text{DOWN}/\text{MHz}$  keys, and then press the  $\text{SET/ENT}$  key.

The display will return to the CONFIG menu, so move the arrow to **END** using the dial or the  $\text{UP}/\text{MHz}$  /  $\text{DOWN}/\text{MHz}$  keys, and then press the  $\text{SET/ENT}$  key. This completes the setting.





## 3.2 Functions common to all modes

This section explains operations common to the VFO, PMS and MR modes.

### 3.2.1 Selecting the signal mode

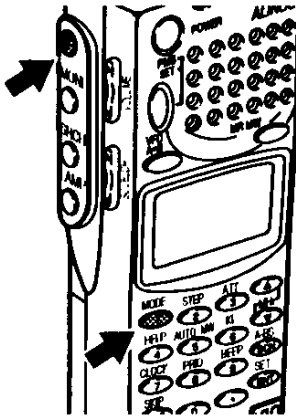

Press the  $\text{F}$  key to display  $\text{F}$ , followed by the  $\text{MODE}$  key. This will display the MODE menu. Then, move the arrow to the signal mode you want, using the dial or the  $\text{MHz}$  /  $\text{V}$  keys, and press the  $\text{ENT}$  key.

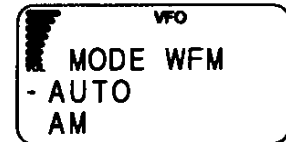

The mode will change in the order of AUTO, AM, NFM, WFM, USB, LSB, and CW. When set to **AUTO**, the DJ-X10 automatically determines the mode from the frequency it picks up referring to the preprogrammed table.

### 3.2.2 Setting the frequency step

Frequency step is the distance that the DJ-X10 moves from one frequency to the next. It can be selected from 20 fixed settings.

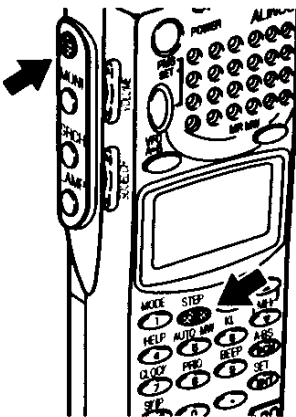

Press the  $\text{F}$  key to display  $\text{F}$ , followed by the  $\text{STEP}$  key. This will display the STEP menu. Then, move the arrow to the step setting you want, using the dial or the  $\text{MHz}$  /  $\text{V}$  keys, and press the  $\text{ENT}$  key.

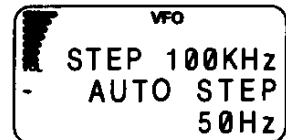

Frequency step setting will change in the order of AUTO STEP, 50 Hz, 100 Hz, 1 kHz, 2 kHz, 5 kHz, 6.25 kHz, 9 kHz, 10 kHz, 12.5 kHz, 15 kHz, 20 kHz, 25 kHz, 30 kHz, 50 kHz, 100 kHz, 125 kHz, 150 kHz, 200 kHz, 250 kHz, and 500 kHz.

When set to **AUTO STEP**, the DJ-X10 automatically determines the frequency step from the frequency band it picks up referring to the preprogrammed table.



### 3.2.3 Attenuating interference from other channels (ATT)

The attenuator lessens interference from strong signals on other channels so that signal you want is heard clearly.

- To turn the attenuator ON

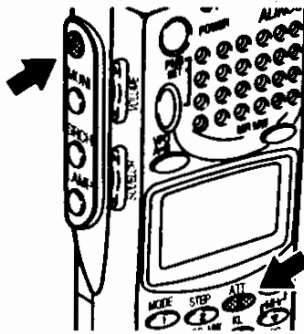

Press the **F** key to display **F**, followed by the **ATT** key. **ATT** will appear at the top of the display. This means the attenuator is ON.

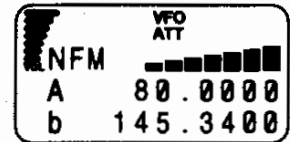

- To turn the attenuator OFF

Press the **F** key to display **F**, followed by the **ATT** key. **ATT** at the top of the display will go out, indicating the attenuator has been turned OFF.

### 3.2.4 Turning the priority function ON/OFF

The priority function checks another channel (priority channel) every 5 seconds while monitoring the current frequency. To set priority mode, see "3.2.8 Setting priority signal condition (PRI MODE)" on page 34. To set frequency (priority channel), see "3.2.9 Setting priority signal channel" on page 35.

- To turn the priority function ON

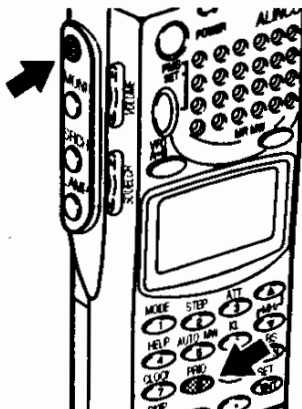

Press the **F** key to display **F**, followed by the **PRIO** key. **PRIO** will appear at the top of the display. This means the priority function is ON.

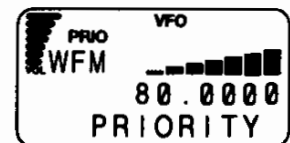

- To turn the priority function OFF

Press the **F** key to display **F**, followed by the **PRIO** key. **PRIO** at the top of the display will go out, indicating the priority function has been turned OFF.

## 3.2.5 Battery Save

When ON, the battery-save feature automatically saves on battery power whenever keys are not used or a signal is not picked up for a certain amount of time.

### 1. Call up the BATT SAVE menu.

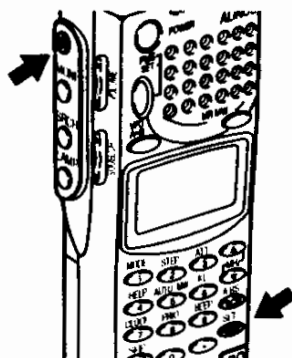

Press the **F** key to display **F**, followed by the **SET/ENT** key. This will display the CONFIG menu. Then, move the arrow to **BATT SAVE** using the dial or the **▲/▼** keys, and press the **SET/ENT** key.



### 2. Turn the battery-save function ON/OFF.

Move the arrow to either **ON** or **OFF** using the dial or the **▲/▼** keys. Then, press the **SET/ENT** key. When set to **ON**, the battery-save function is ON, as opposed to not when set **OFF**.

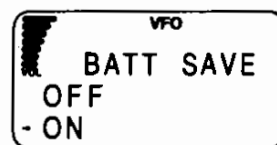

The display will return to the CONFIG menu; Move the arrow to **END** using the dial or the **▲/▼** keys, then press the **SET/ENT** key. This completes the setting.

## 3.2.6 Setting scan resume condition (SCAN MODE)

This setting determines what the DJ-X10 does when it picks up a signal while scanning. This is referred to as the "scan mode".

### 1. Call up the SCAN SETUP menu.

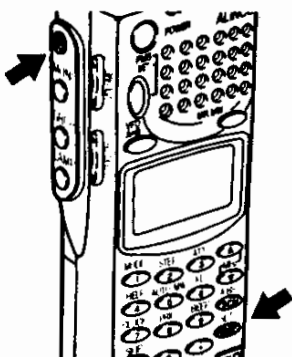

Press the **F** key to display **F**, followed by the **SET/ENT** key. This will display the CONFIG menu. Then, move the arrow to **SCAN SETUP** using the dial or the **▲/▼** keys, and press the **SET/ENT** key.





### 2. Call up the SCAN MODE menu.

Move the arrow to **SCAN MODE** using the dial or the **▲/▼** keys, and then press the **SET/ENT** key.





### 3. Set the scan mode you want.

Move the arrow to the mode you want, using the dial or the  /  keys, and then press the  key. Scan modes available are:



- BUSY** Busy scan. The DJ-X10 stays on any signal it locates until the signal vanishes. Once the signal dies, scanning is resumed.
- STOP** The DJ-X10 stops scanning on the first signal it locates. Scanning is not resumed after the signal vanishes.
- TIMER** The DJ-X10 stops scanning for 5 seconds when it locates a signal. When the 5 seconds elapse, scanning is resumed even if the signal is still being received.





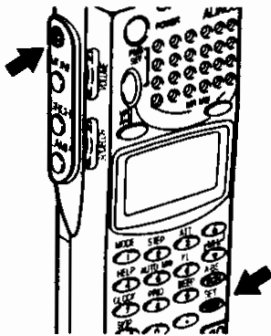

The display will return to the SCAN SETUP menu, so move the arrow to **END** using the dial or the  /  keys, and then press the  key. This completes the setting.

## 3.2.7 Setting scan signal level

This setting specifies the minimum signal level used in scanning. Scanning will stop only when the DJ-X10 locates a signal of this strength or stronger.



### 1. Call up the SCAN SETUP menu.



Press the  key to display , followed by the  key. This will display the CONFIG menu. Then, move the arrow to **SCAN SETUP** using the dial or the  /  keys, and press the  key.







### 2. Call up the S-LEVEL menu.



Move the arrow to **S-LEVEL** using the dial or the  /  keys, and then press the  key

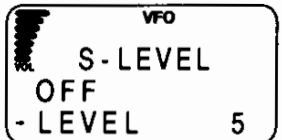

### 3. Set the scans S-level you want.

Move the arrow to **LEVEL** using the dial or the  /  keys. **0** will be flashing on the display; turn the dial to set scan S-level between 0 and 7, then press the  key. If not wanting to set scan level, move the arrow to **OFF**, and press the  key.



The higher the scan level, the stronger the signal that the DJ-X10 searches for. The display will return to the SCAN SETUP menu. Move the arrow to **END** using the dial or the  /  keys, then press the  key. This completes the setting.

## 3.2.8 Setting priority signal condition (PRI MODE)

This setting determines how the DJ-X10 reacts to the priority signal. It is only effective when the priority function is ON. The setting is referred to as the "priority mode" (see "3.2.4 Turning the priority function ON/OFF" on page 31).

### 1. Call up the PRI SETUP menu.

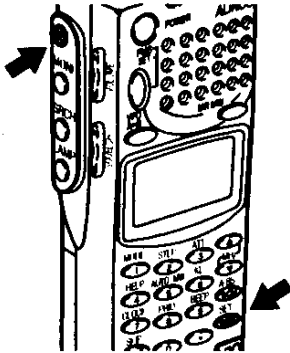

Press the **VFO** key to display **F**, followed by the **SET/ENT** key. This will display the CONFIG menu. Move the arrow to **PRI SETUP** using the dial or the **▲/MHz** / **▼/MHz** keys, and then press the **SET/ENT** key.



### 2. Call up the PRI MODE menu.

Move the arrow to **PRI MODE** using the dial or the **▲/MHz** / **▼/MHz** keys, and then press the **SET/ENT** key.



### 3. Set the priority mode you want.

Move the arrow to the mode you want, using the dial or the **▲/MHz** / **▼/MHz** keys, then press the **SET/ENT** key. Priority modes available are :

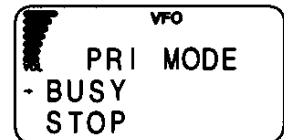

- BUSY** When signal is received on the priority channel, the DJ-X10 stays on the priority frequency until the signal vanishes.
- STOP** When signal is received on the priority channel, the DJ-X10 stays on the priority frequency even after the signal vanishes.
- TIMER** When signal is received on the priority channel, the DJ-X10 stays on the priority frequency for approx. 5 seconds.

The display will return to the PRI SETUP menu. Move the arrow to **END** using the dial or the **▲/MHz** / **▼/MHz** keys, then press the **SET/ENT** key. This completes the setting.

## 3.2.9 Setting priority signal channel

This setting allots a memory channel for the priority scan. The priority scan must be ON for this setting to be effective.

### 1. Call up the PRI SETUP menu.

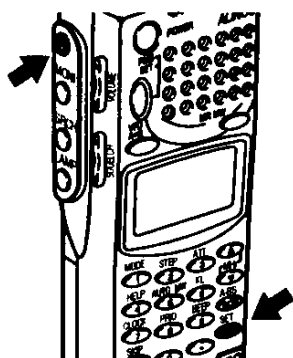

Press the  $\text{P}$  key to display  $\text{F}$ , followed by the  $\text{SET/ENT}$  key. This will display the CONFIG menu. Then, move the arrow to **PRI SETUP** using the dial or the  $\text{Mhz}$  /  $\text{V}$  keys, and press the  $\text{SET/ENT}$  key.



### 2. Call up the CHANNEL setting display.

Move the arrow to **CHANNEL** using the dial or the  $\text{Mhz}$  /  $\text{V}$  keys, and then press the  $\text{SET/ENT}$  key.



### 3. Set the priority signal channel you want.

Select the memory bank (left of "-") and channel (right of "-") using the  $\text{Mhz}$  /  $\text{V}$  keys. Turn the dial to set the bank No. and channel No. then press the  $\text{SET/ENT}$  key.



The display will return to the PRI SETUP menu. Move the arrow to **END** using the dial or the  $\text{Mhz}$  /  $\text{V}$  keys, then press the  $\text{SET/ENT}$  key. This completes the setting.

## 3.2.10 Resetting the receiver

This command resets the DJ-X10. Be careful as all settings you made up till now may be cleared from memory, depending on your selection.

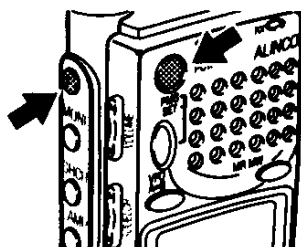

While holding down the  $\text{P}$  key, turn ON the power. When the DJ-X10 starts up, the USER RESET menu will appear on the display. Move the arrow to the reset command you want, using the dial or the  $\text{Mhz}$  /  $\text{V}$  keys. Then, press the  $\text{SET/ENT}$  key. Reset commands are described here following.



**CANCEL** Cancels the reset command entirely.

**SYSTEM** Initializes user-set functions, but it does not clear memory channels. (Choose this normally.)





**ALL** Clears all functions and memories.

## 3.2.11 Setting search step (STEP ZOOM)

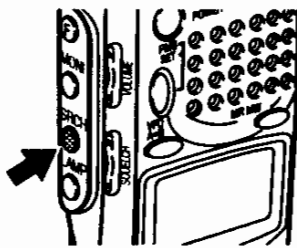
This setting specifies the distance between one search point and the next in the Channel Scope (see "2.9 Searching (Channel Scope)" on page 21). This is referred to as the "search step". The search step can be set in a fraction or multiple of the currently set frequency step. It is effective only when the search mode is set to **CONTINUE** (see "3.2.12 Setting search resume condition (SRCH MODE)" on page 36).



### 1. Call up the STEP ZOOM menu.



Hold down the  key for at least 1 second. This will display the Channel Scope menu. Then, move the arrow to **STEP ZOOM** using the dial or the  /  keys, and press the  key.





### 2. Set the search step.

Move the arrow to the search step desired, using the dial or the  /  keys, then press the  key.

Available search steps are:

- 1/2** Searches will proceed at 1/2 of the set frequency step.
- 1/4** Searches will proceed at 1/4 of the set frequency step.
- 2** Searches will proceed at 2x the set frequency step.
- 4** Searches will proceed at 4x the set frequency step.
- NORM** Searches will proceed at the currently set frequency step.

The display will return to the Channel Scope menu. Move the arrow to **END** using the dial or the  /  keys, then press the  key. This completes the setting.

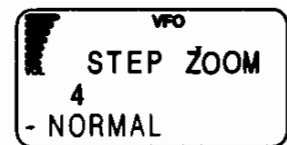





## 3.2.12 Setting search resume condition (SRCH MODE)

For the DJ-X10 to perform the Channel Scope function, its receiver is used for searching the signals, and the sound will be intermit at the moment when the search takes place.

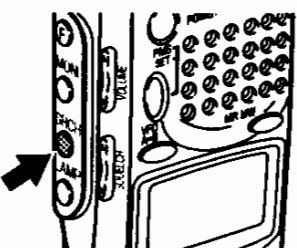
This setting determines how often the search takes place in the Channel Scope function. This is referred to as the "search mode".



### 1. Call up the SRCH MODE menu.





Hold down the  key for at least 1 second. This will display the Channel Scope menu. Then, move the arrow to **SRCH MODE** using the dial or the  /  keys, and press the  key.





## 2. Set the search mode you want.

Move the arrow to the search mode you want, using the dial or the  /  keys, and then press the  key. Search modes available are as follows:



- SINGLE** The search is carried out only once when the  key is pressed. It is not carried out a second time until the first search is turned canceled and the  key is pressed again.
- INTERVAL** A search is carried out once every 10 seconds updating the spectrum condition. Sound is muted the moment the search takes place.
- CONTINUE** Searching is continuous and the spectrum condition is renewed continuously. In this case, no sound is heard from the DJ-X10.

The display will return to the Channel Scope menu, so move the arrow to **END** using the dial or the  /  keys, and then press the  key. This completes the setting.

## 3.2.13 Copying data between two receivers (CLONE)

You can copy settings stored in memory from one DJ-X10 (master) to another (slave). This is referred to as "cloning". Cloning requires a cable with 2.5  $\phi$  stereo plug to connect the two receivers.

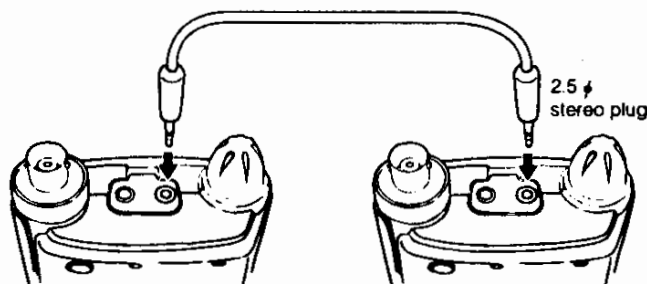

### 1. Connect the two DJ-X10s.

Detach the rubber cap from the CLN terminal on each DJ-X10 and connect the cable between them.



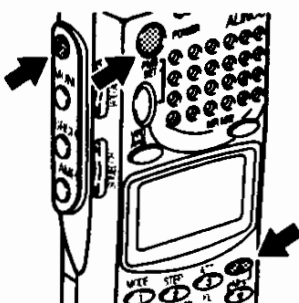

### 2. Execute the cloning command.

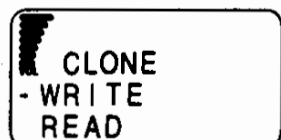

While holding down both the  and  keys, turn ON the power. When the DJ-X10 starts up, the CLONE menu will appear on the display.



Move the arrow to the cloning command you want, using the dial or the  /  keys. Then, press the  key. Cloning commands are as follows:

- READ** Copies the contents of memories from the other DJ-X10, with the operation on the reading (slave) radio only.
- WRITE** Copies the contents of memories to the other DJ-X10, with the operation on the writing (master) radio only.
- END** Cancels the cloning command without copying anything.

While cloning is in progress, the display rapidly alternates between **READ** and **WRITE**.

### 3. Shut OFF the power.

Once cloning has been completed, turn off both radios.



**CAUTION :** While cloning is in progress, do not disconnect the cable or shut OFF power of either of the receivers.

## 3.2.14 Controlling LCD contrast

LCD contrast can be adjusted while the demo mode is displayed.



**NOTE :** If you have the DJ-X10 J-version, the demo mode runs in the Japanese mode; after setting the LCD contrast, you must re-enter the English mode. Details below.

### 1. Call up the demo mode.

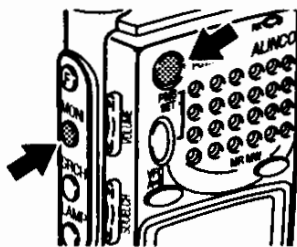

While holding down the **MON** key, turn ON the power. When the DJ-X10 starts up, the demo mode will appear on the display. In the demo mode, only the **▲** / **▼** keys are operative.

### 2. Set LCD contrast.

Press the **▲** / **▼** keys to adjust LCD contrast.

### 3. Quit the demo mode.

To quit the demo mode, turn the power OFF.

### 4. Re-enter the English mode. (For J-version only)

Press the **Ⓞ** key to display **Ⓜ**, followed by the **SET** / **ENT** key. This will display the CONFIG menu. Move the arrow to **LANGUAGE** using the dial or the **▲** / **▼** keys, then press the **SET** / **ENT** key.

Move the arrow to **English** with the **▲** / **▼** keys, and press the **SET** / **ENT** key.



### 3.2.15 Tuning in frequencies in the PMS/MR modes (M.TUNE)

You can tune in frequencies in the PMS and MR modes. You do not have to return to the VFO mode.

- To tune in a frequency

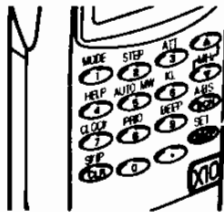

While in the PMS or MR mode, press the **ENT** key. A frequency and **M.TUNE** will appear on the display. Turn the dial or press the **MHz** / **MHz** keys to tune in a frequency.

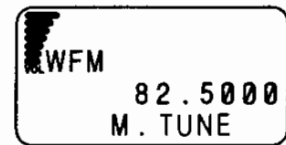

- To cancel M.TUNE

Press the **PMS/SET**, **MR** or **MR/MR** keys.

### 3.2.16 Tuning in the peak signal among the Channel Scope display

During the Channel Scope, you can tune in the strongest signal among the displayed signals in the Channel Scope.

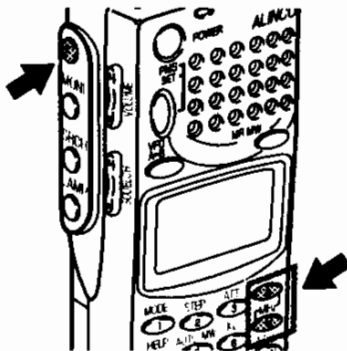

Pressing the **MHz** key after the **MHz** key tunes in the strongest signal towards upper frequency within the scope range, and pressing the **MHz** key after the **MHz** key after the **MHz** key tunes in the strongest signal towards lower frequency within the scope range.



**NOTE :** When there is more than one signal of the same strength, the DJ-X10 tunes in the closest signal to the center of the Channel Scope.

## 3.3 VFO mode functions

This section explains operations in the VFO mode.

### 3.3.1 Mode link between VFO-A and VFO-B (LINK SET)

This function allows changes made on the current VFO to affect also on the other VFO.

#### • To turn the LINK SET setting ON/OFF

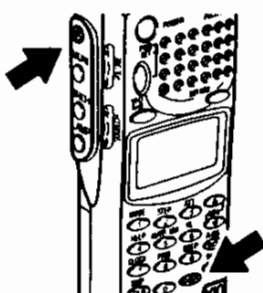

Set frequency on each band A and B.

Press the  $\odot$  key to display  $\mathbb{F}$ , followed by the  $\ominus$  key.

This will display the LINK SET setting. Move the arrow to either **ON** or **OFF** using the dial or the  $\uparrow$  /  $\downarrow$  keys, and press the  $\text{SET ENT}$  key. When set to **ON**, both bands display capital letter A and B, and the link is active. Any changes to the top line band will also be made to the bottom line band. When set to **OFF**, the link function is turned OFF.

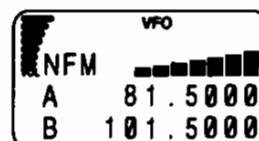

**NOTE:** The bottom line frequency may exceed 1999.999950 MHz (DJ-X10's frequency range upper limit), depending on the top line frequency. In this case, pressing the VFO key switches between top line and bottom line frequencies and cancels the VFO link.

### 3.3.2 Scanning between VFO's A and B (AB SCAN)

This function is for scanning the band between the current frequencies of VFO-A and VFO-B.

#### • To scan between VFO's A and B

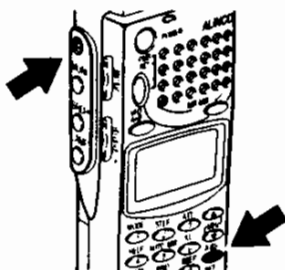

Set frequency on each band A and B.

Press the  $\odot$  key to display  $\mathbb{F}$ .

Then press the  $\text{A-B SCAN}$  key. This will start scanning and will display the arrow next to both bands.

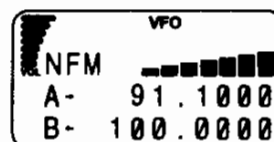

Scanning direction can be changed using the dial or the  $\uparrow$  /  $\downarrow$  keys.

#### • To cancel AB scan

Press the  $\text{A-B SCAN}$  key. This will cancel AB scanning.

### 3.3.3 Copying frequencies from memories to the VFO



You can copy frequencies from a memory channel to the VFO.

#### 1. Call up the frequency in memory.

Press the  key to get the MR mode. Then set the memory bank No. and channel No. you want .

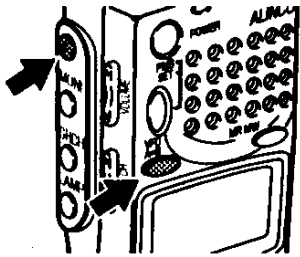
#### 2. Copy the frequency into the VFO.



Press the  key to display  , followed by the  key. The frequency in the selected memory channel will be displayed on the upper line (currently used) band.

### 3.3.4 Copying frequencies from the PMS mode to the VFO



You can copy frequencies in the PMS mode to the VFO.

#### 1. Call up the frequency in memory.

Press the  key to get the PMS mode. Then set the program bank No. you want to display in the VFO mode.

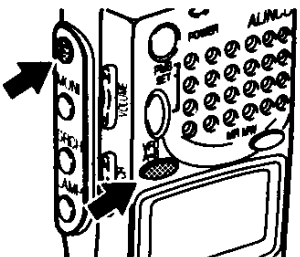
#### 2. Copy the frequency into the VFO.



Press the  key to display  , followed by the  key. The frequency in the selected program bank will be displayed on the upper line (currently used) band the instant that scanning picks it up.

## 3.4 PMS mode functions

This section explains operations in the PMS mode.

### 3.4.1 Programmed scan operations



This section is for programmed scan operations.

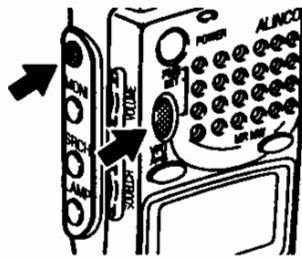

#### 1. Set the scan range in the VFO mode.

Press the  key to get the VFO mode. Then set the scan start frequency on the top line and the end frequency on the bottom line.

#### 2. Select a scanning bank in which to save the program.



Press the  key, followed by the  key. This will display the EDIT BANK display.

Turn the dial or press a numeric key from  to  to set the bank No. (Pressing the  key switches the capital P

and lower case p.) Then press the  key.

```
VFO
EDIT BANK
P0 80.0000
```

#### 3. Set the scan start frequency.

The frequency set on the top line in the VFO mode will appear on the display, so press the  key.



```
VFO
EDIT START
P0 82.0000
```

#### 4. Set the scan end frequency.

The frequency set on the bottom line in the VFO mode will appear on the display, so press the  key.

```
VFO
EDIT END
P0 145.3400
```

#### 5. Name the scan program.

Turn the dial to select a character. Press the  key to enter the character chosen. You can delete character chosen one at a time by pressing the  key. Names can be a maximum of 8 characters long.

```
VFO BS
EDIT NAME
ABCDEFGHIJK
ABC-----
```

#### 6. Save the scan program.

After naming the scan program, press the  key. This will save the scan program and will return to the VFO mode.

## 3.4.2 Setting scan pass-frequency

This setting specifies frequencies to be passed in the scanning operation regardless of signal presence. As many as 50 pass frequencies can be set in a single program bank.

### • To set pass frequencies

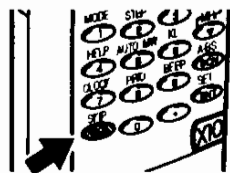

Press the key to get the PMS mode. Then set the program bank where pass frequencies are to be set. Press the key whenever the program stops on a frequency you want to pass.

### • To clear pass settings

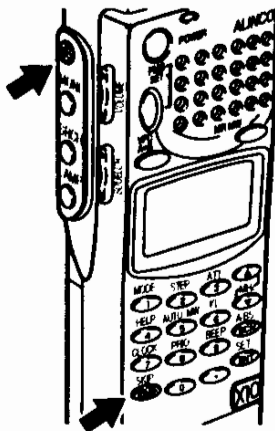

Press the key to display , followed by the key. This will display the PASS EDIT display.

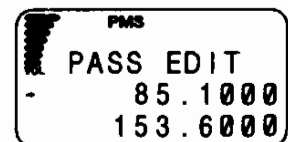

Then move the arrow to pass frequency settings you want to clear, using the dial or the / keys, and press the key. The selected frequency will disappear from the display.

Press the key to exit.

## 3.4.3 Setting program link

This function lets you scan a combination of frequency ranges.

### 1. Call up the PROG LINK display.

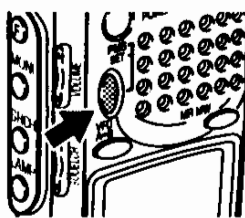

Hold down the key for at least 1 second. This will display the PMS SETUP menu. Then move the arrow to **PROG LINK** using the dial or the / keys, and press the key.

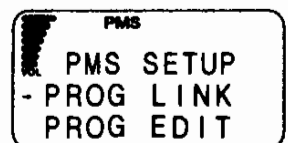

### 2. Set the program bank No.

Input the program bank Nos. you want to scan, using the numeric keys. Pressing the key switches the capital P and lower case p.

To scan all program banks, input all numbers from 0 to 9.

To cancel a bank, enter the bank No. again.

After inputting the bank Nos., press the key.

The display will return to the PMS SETUP menu. Move the arrow to **END** using the

dial or the / keys, then press the key. This completes the setting.

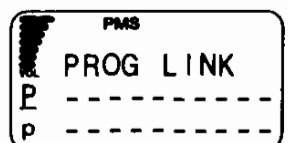



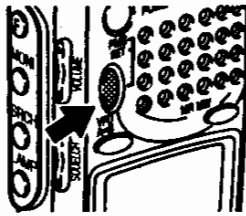

## 3.4.4 Copying scan programs

This function copies scan programs from one bank to another.

### 1. Call up the PROG EDIT menu.



Hold down the  key for at least 1 second. This will display the PMS SETUP menu. Then, move the arrow to **PROG EDIT** using the dial or the  /  keys, and press the  key.

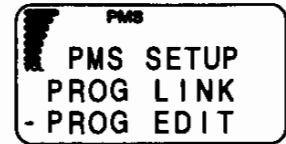



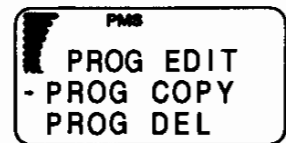

### 2. Call up the PROG COPY display.

Move the arrow to **PROG COPY** using the dial or the  /  keys, and press the  key.





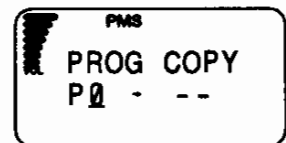

### 3. Set the program bank you want to copy from.

Turn the dial or press a numeric key from  to  to set the bank No. (Pressing the  key switches the capital P and lower case p.) Then press the  key.



### 4. Set the program bank you want to copy to.

Turn the dial or press a numeric key from  to  to set the bank No. (Pressing the  key switches back the capital P and lower case p.) Then press the  key.

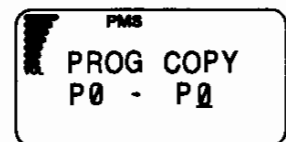

To remake the bank No. settings, press the  key.





The display will return to the PROG EDIT menu. Move the arrow to **END** using the dial or the  /  keys, then press the  key. This completes the setting.

## 3.4.5 Deleting scan programs

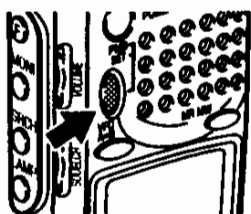
This function deletes scan programs from the program banks.

### 1. Call up the PROG EDIT menu.



Hold down the  key for at least 1 second. This will display the PMS SETUP menu. Then, move the arrow to **PROG EDIT** using the dial or the  /  keys, and press the  key.

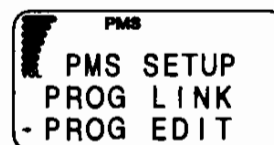



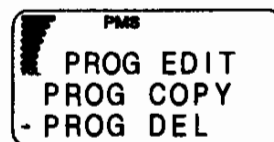

### 2. Call up the PROG DEL display.



Move the arrow to **PROG DEL** using the dial or the  /  keys, and press the  key.



### 3. Set the program bank No. you want to delete.

Turn the dial or press a numeric key from  to  to set the bank No. (Pressing the  key switches the capital P and lower case p.) Then press the  key.



The display will return to the PROG EDIT menu. Move the arrow to **END** using the dial or the  /  keys, then press the  key. This completes the setting.

## 3.5 MR mode functions

This section explains operations into the MR mode.

### 3.5.1 Memorizing frequencies





This function saves selected frequencies into memory channels.

#### 1. Set the frequency you want to memorize, in the VFO mode.

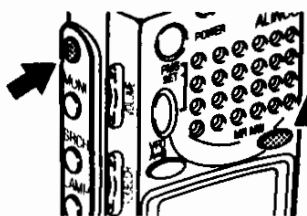
Press the  key to get the VFO mode. Then, set the frequency on the top line (currently used) band.

#### 2. Select the bank No. where the frequency will be saved.



Press the  key to display  and press the  key. This will display the EDIT BANK display. Turn the dial or press the numeric keys to set the bank No. (Pressing the  key switches between banks A, B and C.) Then press the  key.

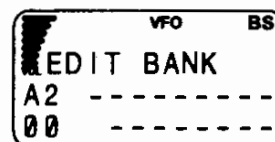

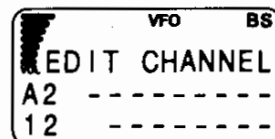

#### 3. Set the memory channel.

Turn the dial or press the numeric keys to set the channel No., then press the  key.



#### 4. Name the memory channel.

Turn the dial to select a character. Press the  key to select specific characters. You can delete characters one at a time by pressing the  key.

Names can be a maximum of 8 characters long.

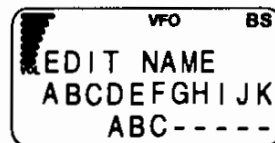

#### 5. Save the memory channel.

After naming the memory channel, press the  key. This will save the frequency in the selected memory channel and will return you to the VFO mode.



## 3.5.2 Setting the Auto Memory Write



This function automatically writes frequencies picked up while scanning in the PMS mode, into memory bank C9 . There are 40 memory channels available from 00 ~ 39.

### 1. Call up a scan program.

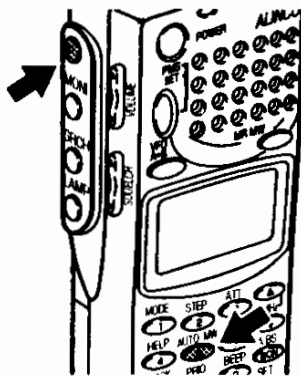

Press the  key to get the PMS mode. Then set the program bank No. where the scan program is stored, and start scanning.

### 2. Set the auto memory write function.

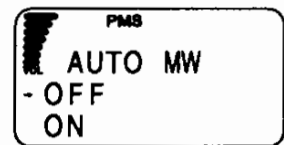

Press the  key, followed by the  key. This will display the AUTO MW







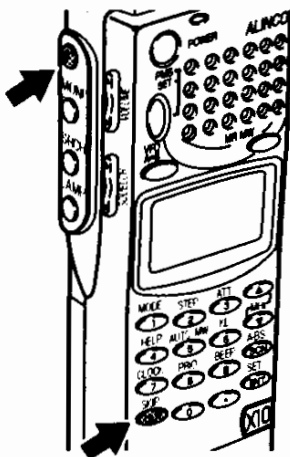

display. Move the arrow to either **ON** or **OFF** using the dial or the  /  keys, and press the  key. When set to **ON**, any frequency on which the scan stops will be written into memory bank C9. When set to **OFF**, the function is OFF.

## 3.5.3 Setting memory scan skip

This setting specifies memory channels to be skipped while scanning in the MR mode. The memory scan will not stop on these frequencies even if a signal is present.

### • To skip memory channels



Press the  key to get the MR mode. Then set the memory channel where skip channels are to be set. Press the  key to display , followed by the  key (or press only the  key). **SKIP** will be displayed to indicate the channel will be skipped during the memory scan.

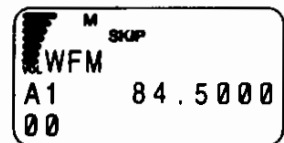

Pressing the  key again will cancel the skip setting.

### 3.5.4 Setting memory scan signal mode (MODE SET)

By setting a mode in the "MODE SEL" menu, the DJ-X10 will selectively scan the memory channels of the specified mode.

#### 1. Call up the MODE SEL display.

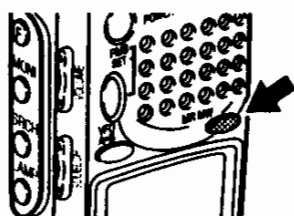

Hold down the **MR** key for at least 1 second. This will display the MR SETUP menu. Then move the arrow to **MODE SEL** using the dial or the **MR** / **MEM** keys, and press the **SET** key.

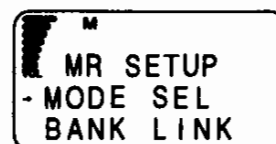

#### 2. Switch to the mode which you want to scan.

Move the arrow to the target mode using the dial or the **MR** / **MEM** keys, and press the **SET** key. Modes will switch in the order of ALL , AM , NFM , WFM , USB , LSB , and CW. When set to **ALL**, the DJ-X10 will scan all channels regardless of mode and automatically determines the mode from the memory channel it picks up.

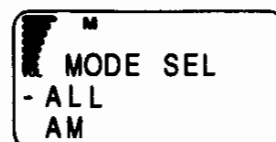

The display will return to the MR SETUP menu, so move the arrow to **END** using the dial or the **MR** / **MEM** keys, and then press the **SET** key. This completes the setting.

### 3.5.5 Using the BANK LINK function

This function lets you scan specific memory banks.

#### 1. Call up the BANK LINK display.

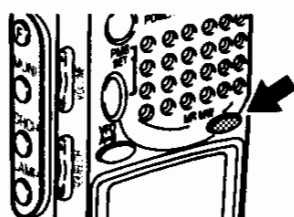

Hold down the **MR** key for at least 1 second. This will display the MR SETUP menu. Then move the arrow to **BANK LINK** using the dial or the **MR** / **MEM** keys, and press the **SET** key.



#### 2. Set the memory bank No.

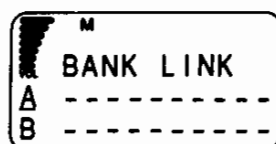

Input the memory bank Nos. you want scan using the numeric keys. Pressing the **MEM** key switches between bank groups A, B and C.

To scan the all memory banks, input all numbers from 0 to 9. After inputting the bank Nos., press the **SET** key.







The display will return to the MR SETUP menu, so move the arrow to **END** using the dial or the **MR** / **MEM** keys, and then press the **SET** key. This completes the setting.

## 3.5.6 Setting memory scan channels (P.MR SETUP)

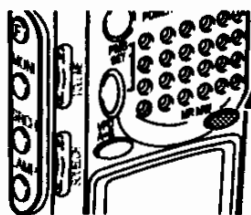
This setting specifies memory channels to be scanned in the memory scan. Up to 100 channels (PG00 ~ PG99) can be set. The memory scan is initiated by pressing the  key followed by the  key.

### 1. Get the P.MR SETUP display.





Hold down the  key for at least 1 second. This will display the MR SETUP menu. Then move the arrow to **P.MR SETUP** using the dial or the  /  keys, and press the  key.

```

M
MR SETUP
BANK LINK
- P.MR SETUP
  
```

### 2. Select the program No. in where scanning memory channels are to be set.





Move the arrow to the program No. you want, using the dial or the  /  keys.

```

M
P.MR SETUP
- PG00-----
  PG01-----
  
```

### 3. Set the memory bank.





Press the  key.

Turn the dial or press a numeric key from  to  to set the memory bank No. (Pressing the  key switches between bank groups A, B, and C.) Move the cursor to the channel area using the  key.

```

M
P.MR SETUP
- PG00  A0-00
  FM
  
```



### 4. Set the memory channel.

Turn the dial or press a numeric key from  to  to set the memory channel No., then press the  key. (To cancel your setting, press the  key.)

```

M
P.MR SETUP
- PG00  A1-00
  PG01  -----
  
```

All the memory channels you want to scan in the memory scan are registered in steps 2 and 3. When finished registering, press the  key.

The display will return to the MR SETUP menu. Move the arrow to **END** using the dial or the  /  keys, then press the  key. This completes the setting.

## 3.5.7 Scanning only memory channels set in P.MR SETUP

This function scans only those channels you set in the P.MR SETUP procedure (see "3.5.6 Setting memory scan channels(P.MR SETUP)" on page 49).

### • To scan only memory channels set in P.MR SETUP.

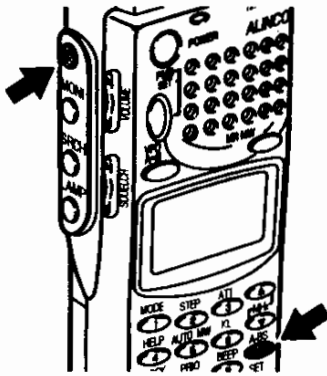

In the MR mode, Press the key to display , followed by the key. Only those channels set in the P.MR SETUP procedure will be scanned. Scanning direction can be changed using the dial or the / keys.

### • To cancel P.MR scanning

Press the key again. This will cancel P.MR scanning.

## 3.5.8 Copying memory banks

This function copies channels from one memory bank to another.

### 1. Call up the MR EDIT menu.

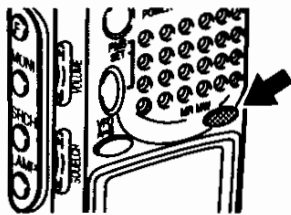

Hold down the key for at least 1 second. This will display the MR SETUP menu. Then move the arrow to **MR EDIT** using the dial or the / keys, and press the key.

```

M
MR SETUP
P.MR SETUP
-MR EDIT
    
```

### 2. Call up the BANK COPY display.

Move the arrow to **BANK COPY** using the dial or the / keys, and press the key.

```

M
MR EDIT
-BANK COPY
-CHNL COPY
    
```



### 3. Set the memory bank you want to copy from.

Turn the dial or press the numeric keys to set the bank No. (Pressing the key switches between bank groups A, B and C.) Then press the key.

```



M
BANK COPY
A0 - -
    
```

#### 4. Set the memory bank you want to *copy to*.

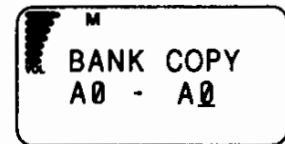
Turn the dial or press the numeric keys to set the bank No. (Pressing the  key switches between bank groups A, B and C.) Then press the  key.



To remake the bank No. settings, press the  key.





The display will return to the MR EDIT menu, so move the arrow to **END** using the dial or the  /  keys, and then press the  key. This completes the setting.

### 3.5.9 Copying memory channels

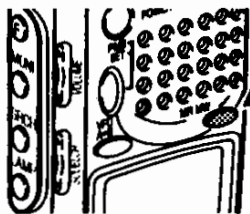
This function copies the contents of one memory channel to another.

#### 1. Call up the MR EDIT menu.



Hold down the  key for at least 1 second. This will display the MR SETUP menu. Then move the arrow to **MR EDIT** using the dial or the  /  keys, and press the  key.

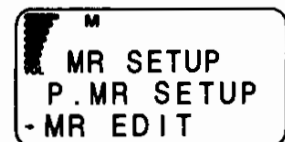



#### 2. Call up the CHNL COPY display.

Move the arrow to **CHNL COPY** using the dial or the  /  keys, and press the  key.



#### 3. Set the memory bank which contains the channel you want to *copy from*.

Turn the dial or press the numeric keys to set the bank No. (Pressing the  key switches between banks A, B and C.) Then, move the cursor to the channel area using the  key.

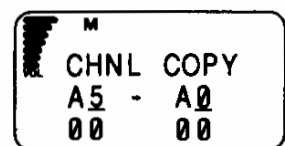

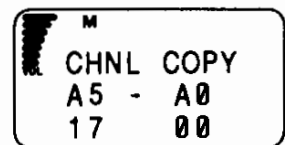

#### 4. Set the memory channel you want to *copy from*.

Turn the dial or press the numeric keys to set the bank No., and then press the  key.



#### 5. Set the memory bank which contains the channel you want to *copy to*.

Turn the dial or press the numeric keys to set the bank No. (Pressing the  key switches between bank groups A, B and C.) Then move the cursor to the channel area using the  key.

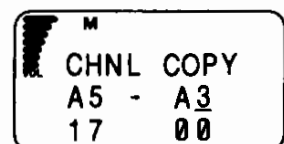

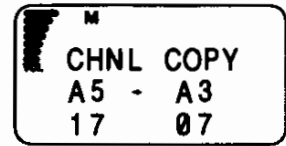

### 6. Set the memory channel you want to copy to.

Turn the dial or press the numeric keys to set the bank No., and then press the  key.



To remake the channel No. settings, press the  key.





The display will return to the MR EDIT menu, so move the arrow to **END** using the dial or the  /  keys, and then press the  key. This completes the setting.

## 3.5.10 Deleting memory banks

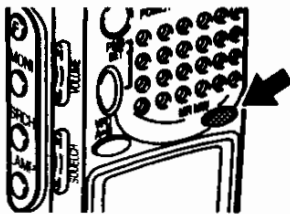
This function deletes entire memory banks.

### 1. Call up the MR EDIT menu.



Hold down the  key for at least 1 second. This will display the MR SETUP menu. Then, move the arrow to **MR EDIT** using the dial or the  /  keys, and press the  key.

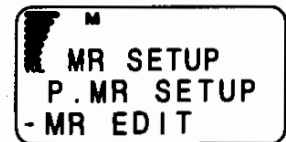



### 2. Call up the BANK DEL display.



Move the arrow to **BANK DEL** using the dial or the  /  keys, and press the  key.

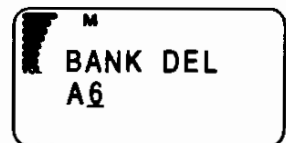

### 3. Set the memory bank No. you want to delete.

Turn the dial or press the numeric keys to set the bank No. (Pressing the  key switches between banks A, B and C.) And, press the  key.



The display will return to the MR EDIT menu, so move the arrow to **END** using the dial or the  /  keys, and then press the  key. This completes the setting.

## 3.5.11 Deleting memory channels

This function deletes contents from the memory channels.

### 1. Call up the MR EDIT menu.

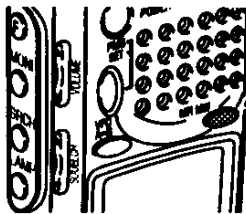

Hold down the **MR** key for at least 1 second. This will display the MR SETUP menu. Move the arrow to **MR EDIT** using the dial or the **MR** / **MR** keys, and press the **SET** key.

```
M
MR SETUP
P.MR SETUP
-MR EDIT
```

### 2. Call up the CHNL DEL display.

Move the arrow to **CHNL DEL** using the dial or the **MR** / **MR** keys, and press the **SET** key.

```
M
MR EDIT
BANK DEL
-CHNL DEL
```

### 3. Set the memory bank No. which contains the channel you want to delete.

Turn the dial or press the numeric keys to set the bank No. (Pressing the **MR** key switches between bank groups A, B and C.) Then move the cursor to the channel area using the **MR** key.

```
M
CHNL DEL
A7-00
-----
```

### 4. Set the memory channel No. you want to delete.

Turn the dial or press the numeric keys to set the channel No., then press the **SET** key.

```
M
CHNL DEL
A7-11
ABC
```

To remake the channel No. settings, press the **SKIP CLR** key.

The display will return to the MR EDIT menu; Move the arrow to **END** using the dial or the **MR** / **MR** keys, then press the **SET** key. This completes the setting.

## 4. Appendix



### 4.1 Specifications

<b>Frequency range</b>	0.1 ~ 1999.999950 MHz*	
<b>Radio systems received</b>	WFM, NFM, AM, USB, LSB, CW	
<b>Frequency steps</b>	50 Hz, 100 Hz, 1 kHz, 2 kHz, 5 kHz, 6.25 kHz, 9 kHz, 10 kHz, 12.5 kHz, 15 kHz, 20 kHz, 25 kHz, 30 kHz, 50 kHz, 100 kHz, 125 kHz, 150 kHz, 200 kHz, 250 kHz, 500 kHz	
<b>Sensitivity (Typ.)</b>	AM	0.1 ~ 0.5 MHz      10 $\mu$ V(20 dB $\mu$ )
		0.5 ~ 5 MHz      1.5 $\mu$ V( 3.5 dB $\mu$ )
		5 ~ 30 MHz      1 $\mu$ V(0 dB $\mu$ )
		30 MHz ~ 1000 MHz      1 $\mu$ V(0 dB $\mu$ ) (1 kHz 30 %mod 10 dB S/N)
	SSB	0.5 ~ 5 MHz      0.5 $\mu$ V(-6 dB $\mu$ ) 5 ~ 30 MHz      0.25 $\mu$ V(-12 dB $\mu$ ) 30 MHz ~ 1000 MHz      0.5 $\mu$ V(-6 dB $\mu$ ) (10 dB S/N)
NFM	5 ~ 30 MHz      0.35 $\mu$ V(-9 dB $\mu$ )	
	30 ~ 1000 MHz      0.25 $\mu$ V(-12 dB $\mu$ )	
	1000 ~ 1300 MHz      1.5 $\mu$ V(3.5 dB $\mu$ )	
	1300 ~ 1999 MHz      10 $\mu$ V(20 dB $\mu$ ) (1 kHz 3.5 kHz 12 dB SINAD)	
WFM	30 ~ 1000 MHz      1.5 $\mu$ V(3.5 dB $\mu$ ) (12 dB SINAD)	
<b>Memory channels</b>	1200	
<b>Search pass mode channels</b>	1000	
<b>Priority channel</b>	1	
<b>Memory banks</b>	30	
<b>Channels per bank</b>	40	
<b>Search bands</b>	20	
<b>Scan speed</b>	Approx. 25 CH/sec	
<b>Antenna connector</b>	BNC, 50 $\Omega$	
<b>Power supply</b>	4.8V DC (Ni-Cd)/6V DC (AA dry cell)	
<b>External power supply</b>	8 ~ 15V DC	
<b>Rated AF output</b>	Min. 100 mW, 10% THD	
<b>Power consumption</b>	At rated output	Approx. 200 mA
	Squelched	Approx. 140 mA
	BS ON	Approx. 30 mA
<b>Weight</b>	Approx. 320 g	
<b>Dimensions</b>	57 x 150 x 27.5 mm (without projections)	
<b>Operating temperature range</b>	-10 ~ +50°C	
<b>Frequency stability</b>	$\pm$ 10 ppm	

\*DJ-X10T (U.S. version) cellular blocked.



## 4.2 Troubleshooting

Trouble	Cause	Remedial action
Nothing is displayed after turning ON power.	<ol style="list-style-type: none"> <li>1. The batteries are loaded backwards.</li> <li>2. The batteries are dead.</li> <li>3. The battery case is not making proper contact.</li> </ol>	<ol style="list-style-type: none"> <li>1. Check battery direction and reload as necessary. See page 12.</li> <li>2. Replace with fresh batteries. See page 12.</li> <li>3. Check for dirt on the battery case or batteries.</li> </ol>
Nothing is heard from the speaker.	<ol style="list-style-type: none"> <li>1. Volume is too low.</li> <li>2. Squelch is too high.</li> </ol>	<ol style="list-style-type: none"> <li>1. Raise volume from the VOLUME  key on the receiver side panel. See page 17.</li> <li>2. First, set squelch to a level static can be heard from the SQUELCH  key on the receiver side panel. Then, set it to the point it is no longer perceived. See page 18.</li> </ol>
Signals are not picked up.	The antenna is not properly attached.	Attach the antenna as explains in "1.4.1 Attaching the antenna" on page 11. For lower frequencies (typ. 60 MHz and down), a random long wire with its end-stub wrapped around the antenna a few turns may help improve reception.
Key inputs are not accepted.	Keys are locked.	Unlock keys. See page 23.
Some functions cannot be used.	The beginner's mode is set.	Switch the USER LEVEL to the expert's mode. See page 29.
A siren-like alarm sounds and the display is faint.	Batteries are dead.	If the  icon appears on the display, change the batteries or recharge the battery pack. See page 12.

## 4.3 Options

The following options are available for the DJ-X10.

EBP-33N Ni-Cd battery pack (4.8 V, 650 mAH)	EME-6 Earphone
EBP-34N Ni-Cd battery pack (4.8 V, 1200 mAH)	ESC-28 Soft case (for use with EBP-33N)
EBP-37N Ni-Cd battery pack (4.8 V, 700 mAH)	ESC-29 Soft case (for use with EBP-37N)
EDC-36 Car lighter cable with active filter	ESC-30 Soft case (for use with EBP-34N)
EDC-63 Wall charger 120VAC	EBC-6 Mobile bracket
EDC-64 Wall charger 220VAC	EDC-37 Base station DC cable
EDC-60 Quick charger 120VAC	EDH-16 Drycell case (AA x 4)
EDC-61 Quick charger 220VAC	

## 4.4 Help function list

Help code	Menu	Submenu	Key	Refer to this section (page) in this manual
#01	HELP	Symbol &	Push 2 Keys together	-
#02	HELP	Symbol !	Press for 1 second	-
#03	HELP	Symbol #	See Manual marked	-
#04	HELP	Symbol →	Select or next step	-
#05	HELP	Symbol +	Up <^> Key	-
#06	HELP	Symbol -	Down <v> Key	-
#07	HELP	Symbol or	or	-
#08	SCAN	NormalScan	VFO→SCN MR→SCN	2.8 (20)
#09	SCAN	Scan A→B	VFO→F&SCN	3.3.2 (40)
#10	SCAN	Mode Scan   ModeSelect	MR!→MODESEL	3.5.4 (48)
#11	SCAN	Mode Scan   ScanStart	MR→SCN	2.8 (20)
#12	SKIP	SKIP SET	PMS→CLR	3.4.2 (43)
#13	SKIP	SKIP EDIT	PMS→F&CLR	3.4.2 (43)
#14	AutoMemory		PMS→F&5 Select ON	3.5.2 (47)
#15	Expert		F&ENT→USER	3.1 (29)
#16	LINK	BANK LINK	MR→BANK LINK	3.5.5 (48)
#17	LINK	PMS LINK	PMS! → PROG LINK	3.4.3 (43)
#18	LINK	VFO LINK	F&	3.3.1 (40)
#19	TIMER	ON TIMER	F&7→ON TIME	2.14.3 (25)
#20	TIMER	OFF TIMER	F&7→OFF TIME	2.14.2 (24)
#21	CLOCK	CURRENT HR	F&7→DISP	2.14.1 (24)
#22	CLOCK	SET	F&7→NOW	2.14.4 (25)
#23	COPY	VFO COPY	VFO→F&VFO	2.7 (20)
#24	COPY	MEM→VFO	MR→F&VFO	3.3.3 (41)
#25	COPY	PMS→VFO	PMS→F&VFO	3.3.4 (41)
#26	COPY	BANK COPY	MR!→EDIT→BNK COPY	3.5.8 (50)
#27	COPY	PMS COPY	PMS!→EDIT PMS COPY	3.4.4 (44)
#28	COPY	MEMCH COPY	MR!→EDIT→C.COPY	3.5.9 (51)
#29	DELETE	MEMORY BNK	MR!→EDIT→B.DEL	3.5.10 (52)
#30	DELETE	MEMORY CH	MR!→EDIT→C.DEL	3.5.11 (53)
#31	DELETE	PMS	PMS!→EDIT→PMS DEL	3.4.5 (45)
#32	PMR	SET	MR!→PMR	3.5.6 (49)
#33	PMR	START	MR→F&SCAN	3.5.7 (50)
#34	CLONE		PWR OFF→F&+&PWR	3.2.13 (37)
#35	DISPLAY	DEMO MODE	PWR OFF→MONI&PWR	3.2.14 (38)
#36	DISPLAY	CONTRAST	DEMO → +OR-	3.2.14 (38)
#37	M.TUNE		MR→ENT PMS→ENT	3.2.15 (39)
#38	ENTER	WRITE MR	VFO→F&MR	3.5.1 (46)
#39	ENTER	WRITE PMS	VFO→F&PMS	3.4.1 (42)
#40	SCOPE	SearchSpan	7CH→F&SRCH 40CH→SECH	2.9 (21)
#41	SCOPE	ZOOM	SRCH!→ZOOM	3.2.11 (36)
#42	SCOPE	PeakSearch	SRCH→F&+OR-	3.2.16 (39)
#43	SCOPE	SearchMode	SRCH!→MOOD	3.2.12 (36)

# 4.5 Menu Trees

**CONFIG (F + ENT; To clear press CLR)**

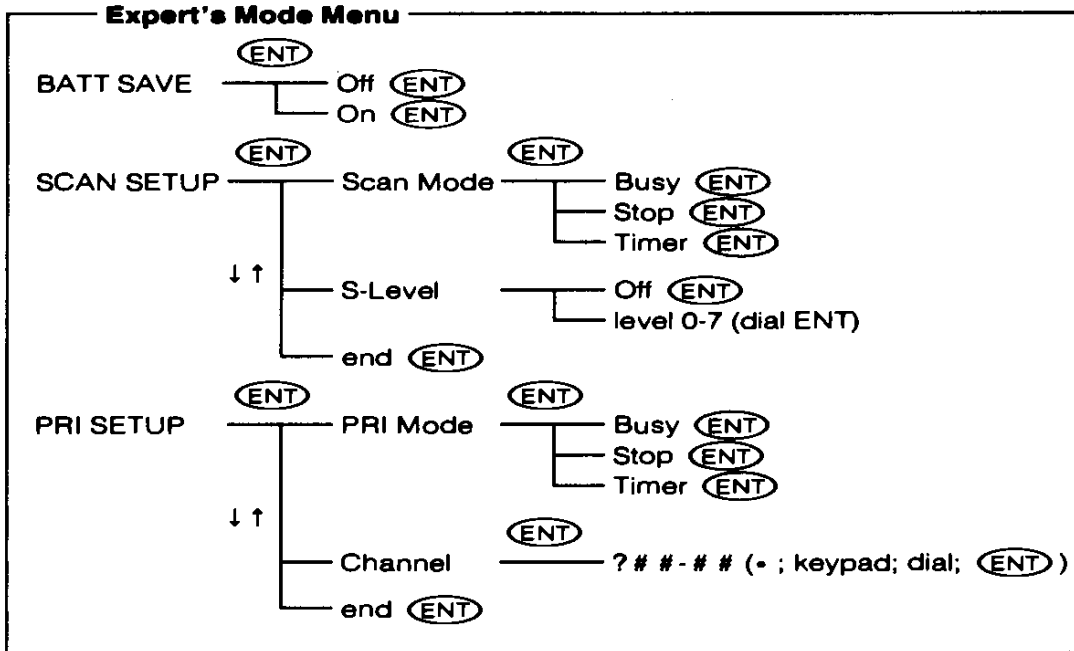
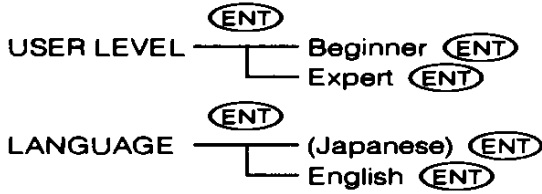

END (ENT)

## Memory Channel Operation

Memory Recall: MR → A/B/C (•); # (keypad); ## (dial)

Memory Write: MW → A/B/C (•); # (keypad/dial) ↓ ↑ # (keypad/dial)

## PMS (Programmed Memory Scan) Setup (Press and hold the PMS key for 1 sec.)

Program Link → (ENT) → (. ; 1~9)

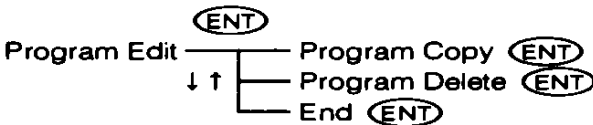

END (ENT)

## Search (Channel Scope) Setup (Press and hold the SRCH key for 1 sec.)

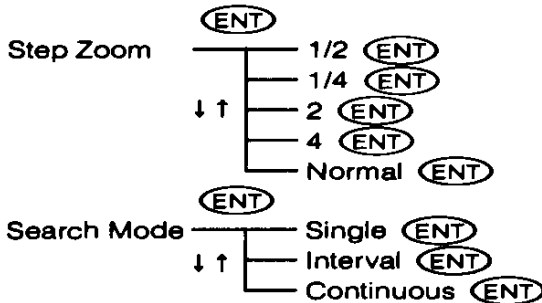

END (ENT)

Note: Always select END after a new setting within the same menu/sub-menu.

## 4.6 Index by Key Words

key word	Section	key word	Section
AB SCAN	3.3.2	mode (beginner's)	see "beginner's mode"
A B S	3.3.2	mode (expert's)	see "expert's mode"
A - B	1.3.1	mode (link)	3.3.1
alarm (low battery)	1.5.5	mode (MR)	see "MR"
AM	see "modulation"	mode (PMS)	see "PMS"
antenna	1.4.1/4.2	mode (scan)	see "scan resume"
ATT	3.2.3	mode (search)	3.2.12
attenuator	3.2.3	mode (signal)	3.2.1/3.5.4
auto memory write	3.5.2	mode (VFO)	see "VFO"
AUTO MW	see "auto memory write"	MODE SEL	3.5.4
backlight	2.11	modulation	3.2.1/3.5.4
band	2.6/2.7	monitor	2.10
bank	3.4.1/3.4.4/3.5.1/3.5.5/3.5.8	MR	2.15.3/3.5/3.2.15/4.5
BANK LINK	3.5.5	MR	1.3.1/2.15.3/3.5
battery	1.5/3.2.5	MW	1.3.1/3.5.1
battery save	3.2.5	name (memory)	3.5.1
beep	2.12	NFM	see "modulation"
beginner's mode	2.2/3.1/4.5	options	4.3
belt clip	1.4.2	P MR SETUP	3.5.6/3.5.7
between VFOA/B	3.3.2	pass	3.4.2
BS	3.2.5	peak search	3.2.16
busy scan	3.2.6/3.2.8	PG	3.5.6
channel scope	see "search"	PMS	2.15.2/3.2.15/3.4/4.5
charging	1.5.4	power	1.3.1/1.3.2/2.1/2.14.2/2.14.3/3.2.5/4.2
clock	2.14	precautions	1.2
clone	3.2.13	PRI mode	3.2.4/3.2.8/3.2.9
CLR	1.3.4	priority	3.2.4/3.2.8/3.2.9
config	3.1/3.2	prog edit	3.4.4
continuous search	3.2.12	programmed memory scan	see "PMS"
contrast	3.2.14	programmed scan	3.4.1
copying frequency	2.7/3.2.13.3.3.3.3.4.3.4.3.5.8.3.5.9	READ	3.2.13
CW	see "modulation"	resetting	3.2.10
DC input	1.3.2	S-level	1.3.3.15/3.2.7
delete	3.4.5/3.5.10/3.5.11	S-meter	1.3.3.15
Demo mode	3.2.14	scan	2.8/2.15.2/3.2.6/3.2.7/3.3/3.4/3.5
display	1.3.3/3.2.14/2.11	scan pass	3.4.2
earphone terminal	1.3.1.3	scan resume	3.2.6/3.2.8
edit	3.4.1/3.4.2/3.4.4/3.4.5/3.5.1	search	2.9/3.2.11/3.2.12
END	4.5	SET	1.3.1
end freq. scan	3.4.1	SET	2.15.2
English	3.2.14	signal level	1.3.3.15/3.2.7
ENT	1.3.4	signal type	see "modulation"
expert's mode	2.2/3.1/4.5	single search	3.2.12
F	1.3.1	skip	3.4.2/3.5.3
FM	see "modulation"	slave	3.2.12
frequency	2.5/2.6/3.2.2/3.3.3/3.4.2	speaker terminal	1.3.1.3
functions	1.3	specifications	4.1
HELP	2.16/3.2.14.4/4.4.5	squeech	1.3.1/2.4/2.10
icon	see "display"	start freq. scan	3.4.1
illumination	see "light"	step	3.2.2/3.2.11
interval search	3.2.12	stop scan	3.2.6/3.2.8/2.8
Japanese	3.2.14	strap	1.4.3
key lock	2.13	symbol	4.4
key pad	1.3.1/1.3.4	SYSTEM	3.2.10
KL	see "key lock"	time	2.14
lamp	see "light"	timer	2.14.2/2.14.3
language	3.2.14	timer scan	3.2.6/3.2.8
LCD	see "display"	troubleshooting	4.2
light	2.11	USB	see "modulation"
link	3.3.1/3.4.3/3.5.5	user level	3.1/4.5
LINK SET	3.3.1	VFO	1.3.1/2.15/3.3
lock	2.13/1.3.2.3	volume	1.3.1/2.3/2.4
LSB	see "modulation"	WFM	see "modulation"
M TUNE	3.2.15	wrist strap	1.4.3
master	3.2.12	WRITE	3.2.13
memory channels	3.5	zoom	3.2.11
menu	4.5		

# ALINCO, INC.

**Head Office:** "TWIN 21" MID Tower Building 25F  
1-61, 2-Chome, Shiromi, Chuo-ku, Osaka 540, Japan  
Phone: 06-946-8150 Fax: 06-946-8175 Telex: 63086  
E-mail: 101243.1446@compuserve.com

**U.S.A.:** 438 Amapola Ave., Suite 130, Torrance, CA 90501-6201, U.S.A.  
Phone: 310-618-8616 Fax: 310-618-8758  
<http://www.alinco.com/>

**Germany:** Eschborner Landstrasse 55, 60489 Frankfurt am Main, Germany  
Phone: 069-786018 Fax: 069-789-60766

Copyright 1997, Alinco, Inc. Osaka Japan  
Printed in Japan PS0275