

**YAESU**



# FT-530

*Dual Band Hand-Held  
Paging Transceiver*

Downloaded by  
RadioAmateur.EU

## Table of Contents

<i>Specifications</i> . . . . .	3	Simple Memory Storage	29
<i>Accessories &amp; Options List</i> . . . . .	4	Recalling Memories	30
<i>Controls &amp; Connectors</i> . . . . .	5	Call Channel Memory	30
Panel Controls	5 & 6	Tuning & Masking Memories	31
Key Functions	10 & 11	Scanning	32
<i>Accessories</i> . . . . .	12	Memory Skip Scanning	33
Batteries & Chargers	12	Programmable Subband Limits	33
DC-Adapter & Batteries	13	Priority Channel Monitoring	34
Speaker/Mics and Headset Accessories	15	AM Receive	35
Antenna Considerations	15	CTCSS Operation	37
<i>Operation</i> . . . . .	17	CTCSS Tone Scanning	38
Preliminary Steps	17	CTCSS "Bell" Paging	38
Frequency Selection Modes	19	DTMF Paging & Code Squelch	40
Keypad, PTT & Dial Locking	20	Individual & Group Codes	41
Squelch Setup	21	Trigger Pager	45
Frequency & Step Selection	21	DTMF Autodial Memories	46
Tuning & Transmitter Power Selection	23	Ringer Settings	48
Selecting Earphone Audio	24	DTMF Settings	49
Mixed (VHF&VHF, UHF&UHF) Receive	24	Clock & Timer Functions	51
Transmitting	25	<i>Extending Battery Life</i> . . . . .	53
Repeater Splits	25	Automatic Power Off (APO)	53
Setting Standard Repeater Offset	27	<i>In Case Of Problems</i> . . . . .	58
Automatic Repeater Shift (ARS)	27	Resetting the CPU & Memory Backup	42
Intelligent Band Selection (IBS)	28	<i>Packet Setup</i> . . . . .	60
Cross Band Repeat Function	28		

## FT-530 Dual-Band Hand-Held FM Paging Transceiver

The FT-530 is a deluxe compact FM hand-held for the 2-meter and 70-cm amateur bands, providing the latest capabilities of dual-microprocessor control, and including dual, separate receivers. Transmitter power output is user-selectable in four levels, up to 5 watts (when used with a 12-volt battery pack or DC supply). The FT-530 offers a multitude of battery preserving features, a 10-memory, 15-digit DTMF (Dual-Tone, Multi-Frequency) autodialler; CTCSS (Continuous Tone-Controlled Squelch System) scanning and a wealth of selective calling/paging features to enhance FM communication.

The sculpted die-cast alloy rear case/heat sink and thick high-impact polycarbonate plastic front panel provide professional-grade ruggedness ideal for demanding applications. The display and translucent keypad have selectable lighting modes. The display includes dual, 5-1/2 digit frequency readouts and indicators for most programmable functions, plus relative signal strength and power output on separate bargraph meters. A DC supply jack is provided on the top panel for powering the

transceiver from an external DC source, and will also charge a 7.2-V Ni-Cd battery pack connected to the transceiver. The easily accessible lithium backup battery is now replaceable without having to open the case. VOX circuitry with adjustable gain/delay is included for hands-free transmit/receive control with the optional YH-2 headset.

Two independent VFOs and 41 freely tunable memories per band are completely programmable from the 20-key keypad; for scanning, independent tx/rx frequencies or programmable offsets, subband limits for band scanning, selectable scan skip for busy channels, selectable scan resume modes, priority monitoring and dual instant-recall CALL channels. In addition, dual receive on different bands, or even on two frequencies in the same band, is possible using main and sub-band receiver VFOs.

Seven standard channel step sizes can be selected; and 1-MHz steps are always available. Automatic Repeater Shift (ARS) can be enabled to set standard repeater shifts automatically when tuned to a standard repeater subband. A 1750-Hz

burst tone generator is provided in European versions (in place of squelch override in other versions). CTCSS is built in for all versions, providing 39 standard subaudible tones which can be stored in each memory independently. The CTCSS Bell feature can be set to sound a paging alert tone when tone squelch opens, and you can scan a channel to identify CTCSS tones being used by other stations.

In addition to the 4-level power output selection and built-in battery charger, unique battery charge life extending features include Yaesu's ABS (Automatic Battery Saver), which monitors operating history and optimizes the save duration accordingly; the industry-first TX Save feature, which reduces transmit power during periods of no modulation or high incoming repeater signal strength; selectable-period APO (Automatic Power Off) to turn off the radio after a period of inactivity; selectable always-on or 5-second display and keypad illumination; and even the capability to disable the **BUSY** LEDs to save power.

The keypad serves as a DTMF encoder during transmission, and up to 10 DTMF memories can

store 15 digits each for quick playback of commonly used numbers. The DTMF-based selective calling and private paging capabilities let you select any of 999 3-digit ID codes for your transceiver, and then have it stay quiet until your code is received (from any standard DTMF-equipped transceiver). Upon receiving the DTMF ID code, you can have a synthesized paging beeper sound (1, 3 or 5 times), and also have the squelch open, or not, as desired. Additionally, in the page mode, when your ID code and a 3-digit ID code of the calling station are received, your display shows his code, so you know who is calling. Six 3-digit code memories store your ID plus those of 5 other frequently-called stations or groups you wish to monitor, and an extra code memory always stores the last 3-digit DTMF code heard.

The MH-29A2B hand Speaker/Mic & Display is available as an option, providing a remote LCD(display) and duplicating most used front-panel keys (including a user-programmable key).

Please read this manual carefully to familiarize yourself with the FT-530 features.

2

## Specifications

### General

- Frequency range: see Version Table
- Channel steps: 5, 10, 12.5, 15, 20, 25 & 50 kHz
- Std. VHF repeater shift:  $\pm 600$  kHz (programmable)
- Emission type: F3 (FM)
- Supply voltage range: 5.5 to 16-V DC
- Power source: 7.2 or 12-V NiCd pack, or external DC power supply
- Current consumption: 190 mA unscquelched, 150  $\mu$ A APO

	144 MHz	430 MHz	Dual Rx
Squelched	60 mA	50 mA	95 mA
Batt. Saver (1:43)	16 mA	15.8 mA	16.8 mA
Transmit (13.8V, 5W)	1.5 A	1.6 A	—

- Operating Temp. Range:  $-10^{\circ}\text{C}$  ~  $+60^{\circ}\text{C}$
- Frequency Stability:  $\pm 5$  ppm
- Antenna (BNC jack): 50- $\Omega$  (rubber helical supplied)
- Case size (WHD): 55  $\times$  134  $\times$  33 mm w/o battery
- Weight (approx): 530 grams with FNB-27 & antenna

### Receiver

- Circuit type: Double-conversion superhet
- IFs: 15.25 VHF, 44.775 UHF, & 455 kHz
- 12-dB SINAD Sensitivity:  $< 0.158 \mu\text{V}$  VHF,  $< 0.18 \mu\text{V}$  UHF
- Selectivity ( $-6/-60$  dB):  $> 12/< 30$  kHz
- AF output (@ 13.8 V, for 5% THD): 0.3 W @8 $\Omega$

### Transmitter

- Power output (@ 13.8 V): approximately 5 W
- Modulation system: variable reactance
- Maximum deviation:  $\pm 5$  kHz
- Spurious emissions:  $> 60$ dB below carrier
- Microphone type: 2-k $\Omega$  condenser
- Burst tone: 1750 Hz (except vers. A)

*Specifications may be subject to change without notice or obligation.*

Version Table (O = no ARS on this band)

Version $\rightarrow$		A1	A2	A3	B1	B2	B3	B4	C1	C2	C3	C4	D	H1	H2	H3	H4
VHF Range (MHz)	144 ~ 146				•				•				•	•			
	144 ~ 148	•				•				•					•		
	Rx: 130-174 Tx: 140-150		•					•				•					•
	140 ~ 174			•			•					•				•	
UHF Range (MHz)	430 ~ 440				o	o	o	o	o	o	o	o		o	o	o	o
	430 ~ 450	•	•	•													
	432 ~ 439												o				
UHF Rptr Shift (default, MHz)	1.6								o	o	o	o					
	5	•	•	•										o	o	o	o
	7.6				o	o	o	o									

## Accessories & Options List

### Rechargeable Ni-Cd Battery Packs

FNB-25	7.2 V, 600 mAh
FNB-26	7.2 V, 1000 mAh
FNB-27	12 V, 600 mAh
FNB-28	7.2 V, 700 mAh

### Compact 15-Hour Chargers

NC-18B	117 VAC, for FNB-27
NC-18C	220/234 VAC, for FNB-27
NC-28B	117 VAC, for FNB-25/-28
NC-28C	220/234 VAC, for FNB-25/-28
NC-34B	117 VAC, for FNB-26
NC-34C	220/234 VAC for FNB-26

### Other Accessories

NC-42	1-Hour Desktop Quick Charger for all above FNB packs
FBA-12	Battery Case for 6 AA-size Dry-Cells
CLIP-3	Belt Clip
BC-1	Bottom Cover (for use without Battery)
CSC-56	Soft Case for FT-530 w/FBA-12/FNB-25

CSC-57	Soft Case for FT-530 with FNB-28
CSC-58	Soft Case for FT-530 w/FNB-26/-27
E-DC-5A	Cig. Lighter DC Cable/Noise Filter
MMB-54	Mobile Hanger Bracket
MH-12A2B	Hand Speaker/Microphone
MH-18A2B	Miniature Hand Speaker/Mic
MH-19A2B	Earpiece/In-Line Miniature Mic
MH-29A2B	Remote Control Speaker/Mic
YH-2	VOX Headset
YHA-29	Rubber flex antenna

*Availability of accessories may vary: some accessories are supplied as standard per local requirements, others may be unavailable in some regions. Check with your Yaesu dealer for changes to the above list.*

Downloaded by  
RadioAmateur.EU

4

## Controls & Connectors

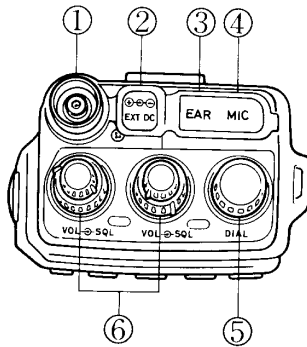

### Top Panel

#### (1) Antenna Jack

This BNC jack accepts the supplied YHA-29 rubber flex antenna, or another antenna designed to provide 50-ohm impedance on the 2-meter and 70-cm bands.

#### (2) EXT DC Jack (under rubber cover)

This 4-mm coaxial jack accepts an external source of 5.5 to 16 volts DC (center contact positive) to operate the transceiver, and to charge a 7.2-V Ni-Cd battery pack if installed on the bottom of the transceiver.

#### (3) EAR Jack (under rubber cover)

The tip contact of this 3-contact, 3.5-mm mini phone jack provides audio output for an optional earphone or speaker/mic (impedance is 8Ω). Main and sub-receiver audio can be mixed, or split between this jack and the speaker.

#### (4) MIC Jack (under rubber cover)



The tip contact of this 3-contact, 2.5-mm phone jack accepts microphone input from an optional microphone or speaker/mic (impedance is 2 kΩ). The ring contact provides DC voltage for the MH-29A2B speaker/mic. The internal microphone is disabled when this jack is used.

#### (5) DIAL Rotary Selector

Use this 20-detent switch to tune, or select memories and other settings such as tuning steps and paging codes, according to the func-

*Note: the protective rubber cover over the jacks must be pulled up (by the tab at the right end) to access the jacks. Press it back over the jacks when they are not in use, to protect the inside of the transceiver from dust and water.*

5

tion selected by the keys. This knob duplicates most functions of the  and  keys for convenience.

**(6) VOL-SQL Controls**

The inner controls adjust the volume of the main and sub receivers. The outer controls set the threshold level at which received signals (or noise) open the squelch. They should normally be set just to the point where noise is silenced (and the corresponding **BUSY/TX** lamp is off) when the channel is clear. If you disable these lamps to minimize current consumption, set the controls by ear.

**Side & Front Panels**

**(1) POWER**

Push this orange button to turn the radio on. Hold it for 1/2 second to turn it off.

**(2) Monitor (Burst), PTT & LAMP Switches**

The three buttons under the rubber cover are activated by pressing the ridges at the top (Monitor/Burst) or bottom (Lamp) of the cover, or the center of the cover (PTT - Push-to-Talk).

The rubber cover over the switches is intended to be permanent, and allows the switches to be operated underneath without removal.

Press the (lower) **LAMP** switch to illuminate the display and keypad when operating in the dark. Pressing only this switch activates the lamp for 5 seconds. Press  first if you want the lamp to stay on (until you press this sequence again). With the radio turned off, the display can be illuminated momentarily at any time for as long as the **LAMP** switch is depressed.

**(3) Battery Release**

Slide this mechanical button upward to install a battery pack, and to release the battery for removal.

**(4) BUSY/TX Indicator Lamps**

These LED indicators glow red when transmitting, and, unless you disable them, green when the noise squelch is open (the channel busy) during reception.

**(5) Liquid Crystal Display**

The display shows current operating conditions as indicated on the next two pages.









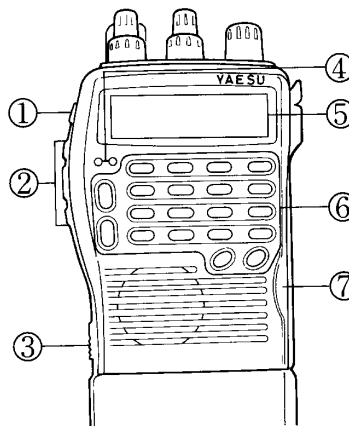

**(6) 20 Rubber Keys**

Sixteen of these keys generate DTMF tone pairs during transmission (all except the blue ones). All keys select operating features of the transceiver during reception. One or two beeps sound whenever a key is pressed (unless the

In the US version, the (upper) Monitor/Burst switch opens the squelch momentarily without disturbing the squelch settings. In the European version, this switch activates the 1750-Hz burst tone generator to transmit the tone (the **PTT** switch does not need to be pressed to transmit the tone).

Press and hold the (center) **PTT** switch while speaking across the front of the transceiver to transmit (the microphone element is near the bottom of the panel). The **BUSY/TX** indicator glows red while transmitting, and pressing the front panel keys transmits a DTMF tone.



keypad beeper is disabled). The labels on the keyfaces indicate primary functions, while labels on the panel indicate alternate functions, activated by pressing  first, and then the desired key within five seconds. For example, to use the alternate (MHz step) function of the  key, press  (momentarily) then  within five seconds (shown as " → " in this manual). Most keys also have two more functions, for setting the modes of seldom-used features. The *setting* level is activated by pressing  →  (each key separately, momentarily) and then one of the other keys. The *alt setting* level is activated similarly, by  →  → . All key functions are summarized in the tables on pages 10 and 11 (by key), and by function on the *FT-530 Operator's Quick Reference Card*. The functions are described in detail in the *Operation* chapter.

**(7) Lithium Battery Access**

This slide-out tray holds the lithium cell used for memory backup. It can be replaced using your fingernail or a small flat screwdriver to slide the tray and cell out from the transceiver body. To save stored data while changing the cell, ensure that a battery pack is connected and the radio is turned on.

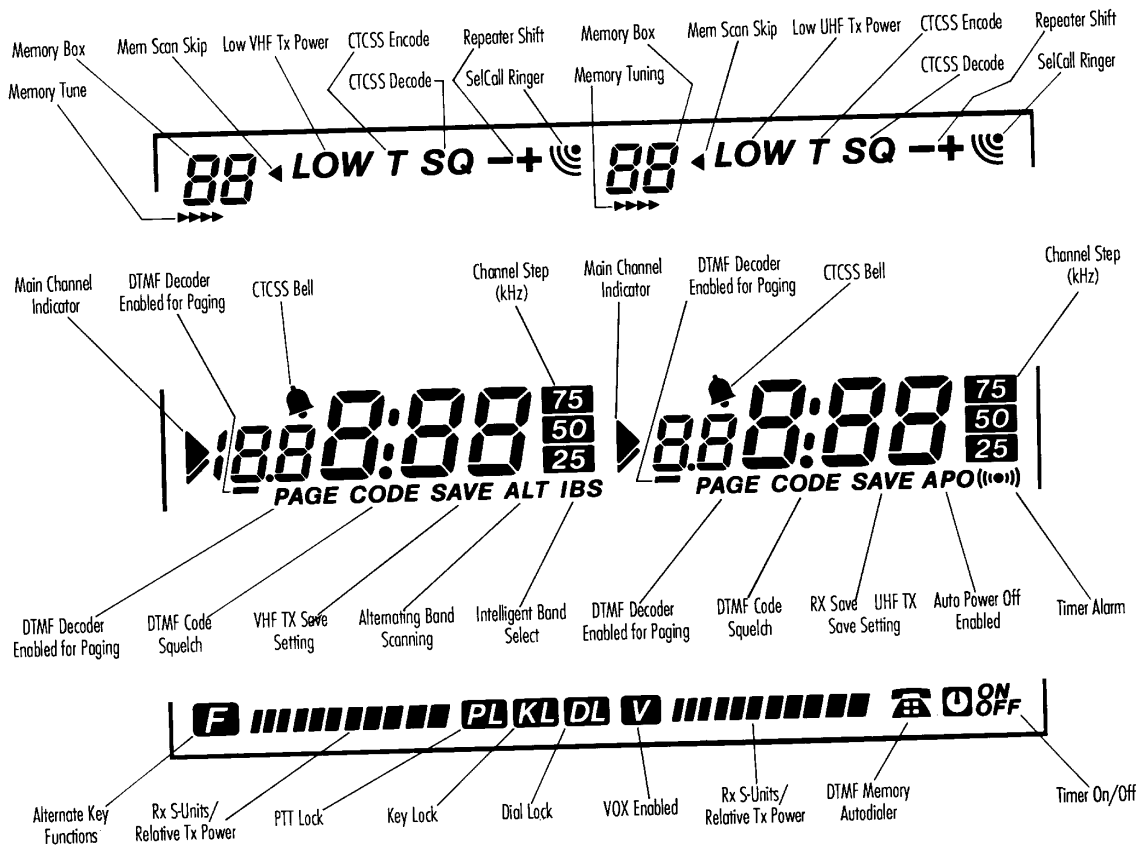

Display	Function	Reference Page #
A, b, C	VFO A, B, or Call Channel	19, 20, 21
SE	Setting Mode	18
L1, L2, L3, HI	Set TX Power Levels	23, 54
AbS	Auto Battery Save	54
Pd 450, 750	Pager Delay (msec.)	45
Pc 1, 3, 5, OFF	Pager Call Beeps	49
AP 10, 20, 30, OFF	Auto Power Off Time (min.)	53
tSON, tSOFF	TX Power Save Function	55
dLON, dLOFF	Dial Lock On/Off	20
d 0.5, 1.0, 1.5	VOX Delay (sec.)	57
PAON, PAOFF	Page Acknowledgment	46
OPON, OP OFF	Optional Paging Code Display	43
trE, t nor	Reverse Key Function	11
SP E I, I E, E E	Earphone Jack Audio Selection (VHF/UHF)	24
rEON, rEOFF	Squelch Override Switch Function	26
thON, thOFF	TX Hang Time	50
APdt, APb	Autodialler Play Function	53
a dt, a b	DTMF/Melody Monitor	49
b dt, b b	Keypad Tone Selection	49
PCON, PCOFF	CTCSS Paging Ringer	49
IkON, IkOFF	Splinter Channel Tuning	22
r on, r OFF	DTMF Row Inhibit	50
c on, c OFF	DTMF Column Inhibit	50
cr on, cr OFF	CTCSS Page Alert Repeat	48
A3on, A3OFF	AM Receive	35
btry, clock	Battery Voltage or Clock	19
Pc dt, b	Pager/CTCSS Alert Melody	48
dS 100, 150	Autodialler Replay Speed	50

## Key Functions

Key	Normal Function	Alt Function (after <b>(EM)</b> ) “E” displayed for 5 sec	Setting Function (after <b>(EM)</b> → <b>(SET 0)</b> ) “SE” displayed until PTT pressed	Alt Setting Function * (after <b>(EM)</b> → <b>(SET 0)</b> → <b>(EM)</b> ) “SE” displayed until PTT pressed
<b>1</b> TONE	Enter digit 1	Toggles CTCSS Encode/Decode Mode: <i>T/T SA</i> off, or cancels CTCSS Tone Frequency display, if active.	Display & toggle DTMF code transmit delay: 450 or 750 milliseconds.	Toggle 1.5-sec DTMF TX hang time
<b>2</b> T SET	Enter digit 2	Toggle Display/setting of CTCSS tone freq. and “b” if key/button beeper enabled ( <b>DIAL</b> and <b>(EM)</b> to change)	Display/set 1, 3 or 5 paging rings (or <i>OFF</i> )	(no function)
<b>3</b> LOW	Enter digit 3	Toggle 4-Step Transmit Power	Display/set 10, 20 or 30 minutes Auto Pwr Off (or <i>OFF</i> = disable)	Select APO alert melody: pre-installed or user programmed melodies.
<b>MHz</b> / <b>MHz</b>	Tune up/down a step or memory	Tune VFO or tunable memory up/down 1 or 10 MHz	Select 1 or 10-MHz step size for these keys	(no function)
<b>4</b> SAVE	Enter digit 4	Display/set Power Saver interval: 1-9 keys set interval, 0 key disables	Toggle TX Power Saver	DTMF Encoder. Monitor DTMF or beeps
<b>5</b> LOCK	Enter digit 5	Lock/Unlock Keypad (“ <b>EM</b> ”), PTT (“ <b>PTT</b> ”), or both	Enable/disable Dial Lock (“ <b>DL</b> ”) with Keypad Lock	Key beeper: use DTMF instead of single tones
<b>6</b> RPT	Enter digit 6	Toggles Repeater Shift direction: <i>-/+</i> off (simplex)	Display/set Repeater Offset (change with <b>DIAL</b> /arrows), and Toggle Auto Rptr Shift ( <b>(EM)</b> )	Toggles CTCSS Paging Ringer
<b>7</b> STEP	Enter digit 7	Display/set tuning steps (set by <b>DIAL</b> ) & scan pause mode ( <b>(EM)</b> ). PTT to return to normal	Disable/enable <b>BUSY</b> LED	Enable keypad entry of valid 1-kHz digits for 12.5, 20 & 25-kHz steps - to select splinter channels
<b>8</b> VOX	Enter digit 8	Toggle VOX/sensitivity <i>Hi/Low/Off</i> (“ <b>VO</b> ”, for YH-2 headset)	Select VOX Delay (0.5, 1.0, 1.5 secs)	<b>Disable</b> DTMF Row Tones**

\* Alt Setting Function descriptions assume starting from default.

\*\* **Caution!** These functions disable DTMF operation!

## Key Functions (continued)

Key	Normal Function	Alt Function (after <b>(EM)</b> ) “E” displayed for 5 sec	Setting Function (after <b>(EM)</b> → <b>(SET 0)</b> ) “SE” displayed until PTT pressed	Alt Setting Function (after <b>(EM)</b> → <b>(SET 0)</b> → <b>(EM)</b> ) “SE” displayed until PTT pressed
<b>9</b> XFER	Enter digit 9	Reverse left and right displays	Toggle Page Acknowledgement	<b>Disable</b> DTMF Column Tones**
<b>CODE</b> <b>PAGE</b>	Toggle Paging/Trigger Code Sql/CTCSS Bell	Display/set DTMF Code Memories	Toggle One-Touch Paging	CTCSS Page Alert Repeat
<b>SKIP</b> <b>MR</b>	From VFO: recall last-used memory. From memory: enable memory tuning (“>>>”)	From memory mode only: toggle scan skip of current memory (“<”)	Reverse Key Functions***	(no function)
<b>0</b> SET	Enter digit 0	Activate “Setting” key mode (only “SE” displayed)	Cancel Setting key mode	(no function)
<b>PRI</b> <b>VFO</b>	From VFO: select VFO “A”/“B” From memory: select last-used VFO	Activate Priority Monitoring	Internal/External Speaker Selection	Enables VHF Band AM receive
<b>(EM)</b>	Enable Alt Functions	Cancel Alternate key functions	Enable Alt Setting Key Functions	Cancel Alt Setting
<b>CALL</b> <b>DTMF</b>	Jump to CALL Channel	Toggle DTMF Autodial Memory Mode (“ <b>AM</b> ”)	(no function)	Select Pager/CTCSS alert melody: pre-installed or user-programmed
<b>BAND</b> <b>ALT</b>	Toggle Main Channel Display (left/right)	Toggle alternating band tuning and memory selection	Toggle Intelligent Band Selection	Toggle Clock /Battery voltage display
<b>SUB</b> <b>OP</b> <b>SUB</b>	Toggle sub channel on/off	Make following key functions act on sub band (“>” blinks on display)	(no function)	(no function)
<b>CLOCK</b> <b>REV</b>	Toggle repeater shift reverse	Display time (for setting)	Toggle repeater input monitor function of Monitor/Burst button	Toggle 100 or 150 ms/tone autodialler replay speed

\*\*\* **Caution!** This function alters key setting sequences. Press **(SET 0)** → **(SKIP MR)** to return to normal.

## Accessories

### Batteries & Chargers

The FT-530 requires the FNB-27 12-volt rechargeable Ni-Cd battery pack for full 5-watt power output. However, where slightly lower power output is practical, the FBA-12 dry-cell battery case (1.5 watts) and the 7.2-volt FNB-25, FNB-26 and FNB-28 Ni-Cd packs (2 watts) offer smaller size, lighter weight or extended charge life. Also, the 7.2-volt Ni-Cd packs may be recharged while attached to the transceiver, using the **EXT DC** jack on the top panel. Any Ni-Cd pack should be fully charged before using it the first time.

Three types of chargers are available: 15-hour compact chargers, the NC-42 1-hour Desktop Quick Charger and the 15-hour internal charging circuit powered by the E-DC-5A Cigarette Lighter Plug Adapter and an external DC voltage source.

Different 15-hour compact chargers are required for different packs:

Ni-Cd Pack	Voltage (DC)	Capacity (mAh)	Compact Charger
FNB-25/28	7.2	600/700	NC-28A
FNB-26	7.2	1000	NC-34A
FNB-27	12	600	NC-18A

12

(see box this page). Be careful to avoid overcharging. Use only with 12-volt negative-ground electrical systems.

### FBA-12 Dry-Cell Battery Case

The FBA-12 dry-cell battery case may be used with six "AA"-size (UM-3) batteries. Maximum power output is about 1.5 watts. Use alkaline cells for best performance.

**Caution!** The FBA-12 must not be used with rechargeable cells. It lacks the necessary thermal and over-current protection circuits provided in the FNB series Ni-Cd Packs.

One or more of the above battery packs/cases may be supplied with the transceiver. If you need a battery, contact your Yaesu dealer. We do not recommend the use of any other type of battery with the FT-530, and using another type may affect your warranty.

### Battery Removal & Replacement

- Make sure that the transceiver is turned off, and remove the protective soft or hard case, if used.
- Grasp the transceiver with your left hand, so your palm is over the display and your thumb is on the Battery Release Button.

Make certain that you use the correct compact charger for each pack. Each compact charger is available with a "B" suffix for operation from 117-V AC, or with a "C" suffix for operation from 220 ~ 234-V AC.

### NC-42 1-Hour Quick Charger

The NC-42 is a universal AC mains battery charger with quick and trickle charging modes for all FNB series Ni-Cd packs listed above. It comes wired for the mains voltage in the area sold. The quick mode is automatically selected initially, to bring the battery pack up to full charge as fast as safely possible using a  $\Delta$ -V sensor. A red LED lights during quick charging, and when the pack approaches full charge, the charger reverts to trickle mode (green LED), to prevent self-discharge. The quick mode recharges a completely discharged battery in about 1 hour, depending on temperature.

### E-DC-5A Cig. Lighter Plug/Adapter

The E-DC-5A connects the **EXT DC** Jack on top of the transceiver to a car lighter socket, to provide operating and battery charging voltage from the automobile electrical system or another DC source

- Move the button in the direction indicated by the arrowhead, while using your right hand to slide the battery case toward the side with the button. The battery case should slide smoothly out of its track.

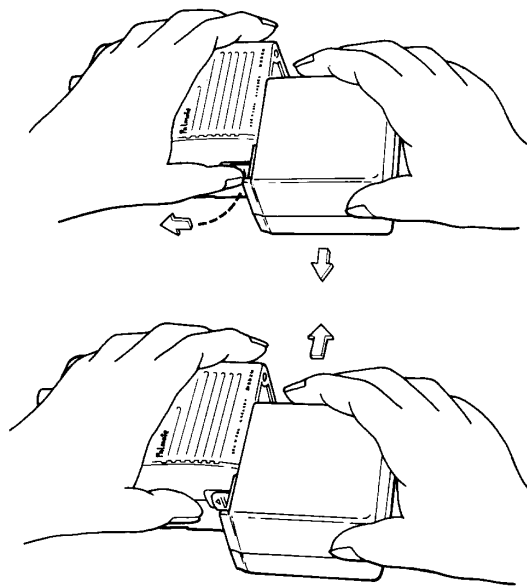

**Battery Removal**

13



To open the FBA-12 battery case, place your thumbs on the tracks on top of the case and gently pry the tracks apart. Always replace all six batteries, paying attention to the polarity indicated inside the case.

✘ *Do not attempt to open any of the rechargeable Ni-Cd packs, and do not install rechargeable cells in the FBA-12, as they could explode if accidentally short-circuited.*

To replace the battery case or Ni-Cd pack, repeat the second and third steps above, simply sliding the battery case in the other direction after

aligning the rails of the battery case with the tracks below the Battery Release Button.

### **MH-12A2B, MH-18A2B MH-29A2B Speaker/Microphones**

A Speaker/Mic can increase operating convenience and extend communications range. The external loudspeaker can be used with the internal speaker to monitor both channels during dual receive operation. Each speaker/mic has a dual plug connector which mates with the **EAR** and **MIC** jacks on the transceiver, disabling the internal microphone. The cable allows the transceiver to be left clipped to your belt, or to be held above ob-

### **Operating & Charging with an External DC Supply**

The E-DC-5A or another cable with a 3.5-mm coaxial plug that matches the **EXT DC** Jack can be used to operate the transceiver from a source capable of providing 1.5 amperes at 5.5 to 16 VDC.

To charge a battery through this jack, the supply voltage must be at least 2 volts higher than the nominal battery voltage (9.2 volts for the FNB-25, -26 and -28, or 14 volts for the FNB-27). Charging time depends on the battery capacity and state of charge, and is typically 18 hours for the FNB-25/-27, 21 hours for the FNB-28, and 30 hours for the FNB-26, when fully discharged. Be careful to avoid overcharging a battery pack when using an external DC supply: when a battery is fully charged, disconnect it and install a BC-1 bottom cover on the transceiver to protect it.

structions for better performance. Also, using a speaker/mic for mobile operation allows the transceiver to be left in the MMB-49 Mobile Hanger.

Hold the speaker/mic close to your ear during reception; or connect an earphone to the plug on the speaker/mic, attenuating the audio from its loudspeaker. To transmit just hold the speaker/mic about 4 cm (2 inches) from your mouth and close the **PTT** switch on the microphone.

### **MH-19A2B Earpiece/Microphone**

The MH-19A2B works like the speaker/mics described above, but consists of an earpiece and inline microphone/**PTT** switch element. The earphone is inconspicuous and ideal for monitoring in noisy or crowded areas, while the microphone has a clip for attaching to a shirt or jacket collar. Press the **PTT** switch on the microphone to transmit.

### **MH-29A2B Remote Control Speaker/Microphone**

The MH-29A2B enables radio functions such as VFO/Memory selection and tuning to be remote controlled and viewed on a backlit LCD. Some first-level functions can also be selected.

### **YH-2 VOX Headset with Boom Microphone**

The YH-2 connects to the **EAR** and **MIC** jacks in the same manner as the speaker/mics. It consists of a headband-supported earphone and attached boom microphone, allowing hands-free operation when VOX (voice-actuated transmit switching) operation is activated in the transceiver.

### **Antenna Considerations**

While the supplied YHA-29 rubber flex antenna is convenient for short-range operation, the standard BNC jack allows use of a higher gain antenna to extend range in base or mobile operation. Any antenna used with the FT-530 should have an impedance close to 50 ohms in the 2-meter and 70-cm bands. If a feedline is used, it should be good quality 50-Ω coax. Obtaining a proper fit with some BNC plugs may require removing the rubber gasket around the antenna jack on the transceiver.

# Operation

This chapter describes the various transceiver functions tutorially. After studying these descriptions, keep the *FT-530 Operator's Quick Reference Card* handy to refresh your memory.

## Preliminary Steps

Before operating the FT-530 the first time:

- Charge the battery pack completely (if using Ni-Cd batteries) as described on page 13. If using an FBA-12 dry-cell battery case, install the batteries as described on page 14.
- Connect the supplied antenna to the antenna jack on the top of the transceiver. *Never operate the transceiver without an antenna connected.*
- If you have a Speaker/Mic, we suggest you not connect it until you are familiar with basic operation.
- Before proceeding, please read the *Controls & Connectors* chapter, if you have not already, to familiarize yourself with the functions of the controls. Note especially the display on pages 8 & 9, and the key information on pages 10 through 11.

When the front panel keys are pressed during reception, one or two beeps will sound to indicate key contact. Don't hold the **(EM)** key down unless you are storing a memory, and don't press two keys as the same time. While transmitting, the keys generate DTMF tones according to their numeric label or the amber **A, B, C, D, \*,** or **#** label.

You need not be too concerned about the following descriptions of timers — they are much easier to learn (by doing, which we will get to shortly) than to describe.

A five-second timer starts when you press **(EM)**, and automatically restarts when you turn the selector knob or press an arrow key. Pressing

### Low Battery Indicator

When battery voltage drops below about 5.5 volts, the display begins alternately flashing the battery voltage, indicating the battery pack should be recharged or batteries replaced. If you continue operating, the transceiver turns itself off.

### Key Beeper

You can toggle the key beeper on and off by pressing **(EM)** → **(TSET 2)** → **(EM)** → **(TSET 2)**. If you lock the keypad (page 20) with the beeper enabled, each key will sound a different musical note for as long as it is held.

other keys may shut off the timer as the resulting change in operation occurs, or start a different timer for selecting a parameter. When the setting mode (after **(EM)** → **(SET 0)**) is activated the display is blanked, except for "SE" appearing in the memory box. Pressing any key at this point will alter the operation of the transceiver according to the descriptions of the *setting mode* features. To exit the setting mode and return the display to normal, you can either press the **(EM)** key, PTT switch (no transmission will occur), or turn the set off and back on.

A beeper provides useful audible feedback whenever a key is pressed, at a level determined by either volume control. Each key has a different beep pitch, and many functions have unique beep combinations. For example, you will hear a low-

pitched beep followed by a high-pitched beep when you press **(MHz ▲)**, or a high-pitched beep followed by a low-pitched beep when you press **(MHz ▼)**. These beeps are helpful when setting up transceiver functions. You can disable the beeper as described in the box above, but we recommend keeping it enabled while getting to know the controls and special multi-key functions.

If you have trouble getting the transceiver to work as described, see *In Case of Problems*, on page 58.

### Important Terms

If the transceiver has not been used before, the display will look something like this:

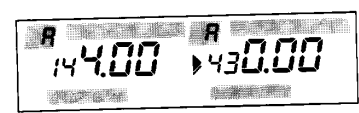

We call the frequency indicated by "R" to its left the *main channel*, and the other frequency (if any), the *sub channel* (these can be on either side of the display). You can turn the sub channel frequency display on and off by pressing **(MEM)**. As you might expect, dual receive is active only when a sub channel is displayed. The **(BAND ALT)** button selects which

b:  
d:  
r:  
re  
w  
w  
B  
r:  
a:  
P  
  
a  
ii  
ii  
c  
n  
a  
7  
  
F  
v  
-  
t  
t  
r  
r

band or bands appear in the main and sub channel displays. Transmission is possible only on the main channel, but you can select both channels to receive different frequencies on the same band, as well as on different bands, simultaneously. Along with the separate volume and squelch controls and BUSY/TX LEDs, each channel display has its own memory box above and to the left of the frequency, and its own bargraph meter for signal strength or power output indication.

Normally, the selector knob and key functions affect only the main channel. However, by pressing (EM) → (SUB) first so that "►" is displayed (blinking) next to the sub channel, you can cause the controls to act on the sub channel instead. After making adjustments to the sub channel, press (SUB) alone to return control to the main channel.

### Toggling Sub-Channel Display

During single-receive operation, half of the display can be set to display the time of day, battery voltage, or be turned off. Press (EM) → (SET 0) → (EM) → (BAND ALT) and then repeatedly press (BAND ALT) to step through the various selections. The current selection is indicated by "clock", "btry", or "---" for no display. Press (SET 0) to save your selection and return the display to normal.

### Frequency Selection Modes

#### VFO Mode

This mode is for tuning or scanning the band when looking for a channel on which to operate, when you don't have a specific frequency in mind. In this mode, the selector knob and arrow keys each tune the band in the selected step size, or 1- or 10-MHz increments, and the scanning function tunes in the selected step size. The FT-530 has two independent VFOs (A and B), for the main channel, and two more for the sub channel. You toggle between the A and B VFOs by pressing (PRI VFO) when receiving. The currently selected VFO is indicated by an "A" or "B" in the corresponding memory box above and to the left of the channel frequency.

#### Memory Mode

This mode is mainly for operating on specific channels known in advance (and stored in the memories). For example, after storing the frequencies of your local repeaters into memory channels, you can confine operation to those channels by selecting the memory mode. In this mode, the DIAL knob, arrow keys and scanning function select sequentially from stored memories. The FT-530 has

41 memories per band, each of which can store repeater shift direction, CTCSS settings and separate receive and transmit frequencies.

Each memory has a Memory Tune mode, in which you can tune just like the VFO mode, and store the resulting retuned memory into the same or another memory. This and other special mem-

ory mode functions are described later, but you will want to keep these terms in mind.

You can tell at a glance which frequency selection mode is active by looking in the shaded memory box at the upper left corner of the display. If the box is empty (and a small "A" or "B" appears below the box), you are in the VFO mode. If you

see a box, The ' from mod serv men is al

#### Squ

T spec lowi  S w fc  T gl w is ch  A is S si

### Keypad, PTT & Dial Locking

The PTT switch, keys and DIAL knob can each be "locked" (disabled), to prevent inadvertent transmissions or adjustments. You will find PL, KL and possibly DL displayed at the bottom center when any of these are locked. Whether any locks are active or not, you can always press (EM) → (LOCK 5) to gain control of the locks for 3 seconds, during which you can press (LOCK 5) again repeatedly to step through the locking combinations, and off (no indicator).

If you want to also lock the DIAL knob, you'll need to enable this function first before selecting it. Press (EM) → (SET 0) → (LOCK 5), your display will indicate "dL OFF", by pressing the (LOCK 5) key again, "dL ON" will appear, indicating the dial lock is turned on. Press (SET 0) to save and return the display to normal. After this, KL DL appear together whenever you lock the keypad, indicating that the DIAL knob is locked too. Repeat the previous key sequence to turn off the dial lock

Remember, to disable all locks regardless of state, press (EM) → (LOCK 5) and then (LOCK 5) again as many times as necessary to clear the lock indicators.

You will want to enable the locks if you hand the radio to someone who might disturb your settings. Pressing the keys while locked causes different musical notes to sound for as long as the key is held, but only the unlocking sequence affects operation.

see a small number or an "L", "U" or "C" in the box, you are in the memory mode.

The **SKIP** key activates the memory mode from the VFO mode, and **PRI** **VFO** activates the VFO mode from the memory mode. While in the memory mode, your previous VFO mode selections are preserved. Also, when you switch between VFO and memory modes, the last-selected memory or VFO is always the one recalled.

### Squelch Setup

The two (outer) squelch controls affect the respective left and right channel displays. The following description applies to either.

- Set the outer **SQL** control fully counterclockwise, and adjust the inner **VOL** control for comfortable volume on the noise or received signal.
- The corresponding **BUSY/TX** indicator will glow green to indicate that the squelch is open, unless you have disabled it (page 55). If a signal is present, turn the **DIAL** on the top panel to a channel with only background noise.
- Adjust the **SQL** just to the point where the noise is silenced and the LED is extinguished. (If the **SQL** is set further clockwise, sensitivity to weak signals is reduced.)

Now, whenever a signal reaches the receiver strong enough to open the squelch, the **BUSY/TX** indicator will glow green.

Note that while receiving, one or more bargraph segments may appear along the bottom of the display, indicating received signal strength. This is not affected by the squelch, so even squelched signals can give some indication. If several bargraph segments appear while the squelch is closed, try reducing the **SQL** setting (if you want to hear weak signals).

The squelch override switch on non-European versions (the upper ridge on the rubber cover on the left side) opens the squelch so you can check for signals beneath the squelch level, and adjust volume independently of the squelch. This switch can also be configured to allow momentarily checking a repeater input frequency (see the box on page 26).

### Frequency & Step Selection

You can select a new frequency from a VFO, or by tuning a memory. For now, we suggest using the VFO mode: if you see a memory number in the memory box, press **PRI** **VFO** to switch to VFO mode. You can enter a new frequency directly by the

**MHz** and **MHz**. See the box on the previous page if the keys or knob don't work.

#### Direct Numeric Keypad Entry

To enter a new frequency directly, just press the digits corresponding to the desired frequency, starting from left (100's-of-MHz) to right. When you press the first key, the display clears and only the new digit appears. When you press the last key, the display reverts to normal, showing the new operating frequency to 6 digits (if it was valid), or the original frequency (if it was not: 2 beeps sound).

**Example:** To operate on 146.94 MHz:

- Press **1** → **4** → **6** → **9** → **4** and, if a trailing zero doesn't appear, **0**.

If your set covers the 146- to 147-MHz range, you should now see "146.940" displayed as your operating frequency. Otherwise, you should have heard 2 beeps, and the display should be as before (try an in-band frequency).

If your set is using 12.5- or 25-kHz steps, *nothing happened* when you pressed **4**, since this frequency is not a multiple of these steps. Just press any other number (except **9**) to get the nearest resulting 12.5-kHz channel. Notice that you can

enter 12.5-kHz splinter channels this way, but subsequent tuning is still in the selected step size, if it is larger (see below).

**Note:** There's a short-cut for frequencies ending in zeros — press **PRI** **VFO** after the last non-zero digit.

**Example:** To operate on 146.000 MHz:

Press **1** → **4** → **6** → **PRI** **VFO**

Don't worry if you get stuck, you can always press the PTT to cancel your entry and return to the previous display.

#### Tuning Splinter Channels

If you use 12.5, 20, or 25-kHz tuning steps and want to have keypad access to 5-kHz channels, you can enable a 4th key during keypad entry. Press **MEM** → **SET** **0** → **MEM** → **STEP** **7**, ("Ik on" will be displayed) and then the PTT switch. Note that even if you enable this, the splinter channeling is canceled when you retune. To turn off this feature, repeat the above key sequence ("Ik OFF" will confirm your entry).

I  
pres  
prev  
  
Tur  
  
key  
sele  
key  
it ar  
pre  
able  
arro  
step  
  
I  
in a  
ver  
oth  
the  
retu  
  
l  
mu  
UH  
two  
ing  
The

Don't worry if you get stuck, you can always press the PTT to cancel your entry and return to the previous display.

### Tuning

You can turn the **DIAL**, press the  $\frac{\text{MHz}}{\Delta}$  /  $\frac{\text{MHz}}{\nabla}$  keys, or use direct keypad input to tune in the selected step size. If you press and hold an arrow key for continuous tuning, you will need to release it and then press it again momentarily (to stop, and prevent scanning). One-MHz steps are also available: just press **(EM)** before pressing either of the arrow keys (and hold the arrow key for repeated stepping), or press **(EM)** and turn the **DIAL**.

Default UHF channel (tuning) steps are 25 kHz in all versions, and VHF steps are 5 kHz in A versions, and 25 kHz in B versions. To select another step size, press **(EM)**  $\rightarrow$   $\frac{\text{STEP}}{7}$  turn the **DIAL** for the desired steps, and then press  $\frac{\text{STEP}}{7}$  again to return to normal operation.

Don't forget that while the FT-530 permits simultaneous dual-band reception on VHF and UHF, it also lets you simultaneously receive on two frequencies *within the same band*. It's like having *two* receivers at your command for each band! There are a few things, however, that you should

### Transmitter Power Selection

Press **(EM)**  $\rightarrow$   $\frac{\text{LOW}}{3}$  to select either high, or one of three low power settings: "L1", "L2" or "L3" (displayed for 3 seconds). Also during selection, the bargraph meter indicates the relative power level. Note that the lowest level draws the least current, and so provides the longest battery charge life.

To change the low power level, press **(EM)**  $\rightarrow$   $\frac{\text{LOW}}{3}$  and  $\frac{\text{LOW}}{3}$  again if "Hi" is displayed. Then turn the **DIAL** or use the arrow keys to choose a low level. Press the PTT or wait 3 seconds for the display to return to normal.

Display	@7.2 volts (approx.)		@12 volts (approx.)	
	watts	mA	watts	mA
<b>L1</b>	0.5	400-800	0.5	600
<b>L2</b>	1.5	500-1000	1.5	850
<b>L3</b>	2	500-1000	3	1100
<b>Hi</b>	2	1000	5	1500

know about VHF & VHF and UHF & UHF reception with your transceiver.

Simultaneous VHF or UHF frequency reception is accomplished by first using *direct keyboard entry* of the desired frequency (within the range of your particular version) on the alternate display. Afterwards, the  $\frac{\text{MHz}}{\Delta}$  /  $\frac{\text{MHz}}{\nabla}$  keys and the **DIAL** are used for tuning and scanning operation on either receiver. Returning to normal reception (VHF & UHF) can be accomplished in the same manner (simply enter a valid frequency using the keyboard). During simultaneous receive, when tuning UHF on the left receiver, reception will automatically "loop around" when the band limits are reached, as before. However, if your transceiver version has extended VHF receiver coverage, when tuning *outside* of the 2-meter band on the right receiver, the coverage will not be as wide. You can continue tuning/scanning until the frequency display begin flashing, indicating the band limit has been reached and the PLL is unlocked. Simply return to an in-band frequency (the display returns to normal). Receiver performance may decline slightly when receiving on the alternate receiver (specifications are guaranteed using normal reception within Amateur Bands only).

### Note!

VHF transmission is only possible on the left-hand display, and UHF transmission is only possible on the right-hand display ("Err" will be displayed if you attempt to transmit), although either display can be used for receiving on either band. Also, remember that transmission only occurs on the currently selected main channel. Do not transmit on one frequency while tuned to the same frequency on the other receiver.

### Selecting Earphone Audio

Full-duplex cross-band operation requires using an optional earphone or headset to prevent audio feedback or "howling" from the internal speaker. You can select which receiver's audio will be output to the **EAR** jack on the top panel of your transceiver by pressing **(EM)**  $\rightarrow$   $\frac{\text{SET}}{0}$   $\rightarrow$   $\frac{\text{PRI}}{\text{VFO}}$ . "SP" will appear followed by the left and right receiver's selected audio output; "E" for earphone jack, or "I" for internal speaker. The three combinations (E I, I E & E E) can be selected by toggling the  $\frac{\text{PRI}}{\text{VFO}}$  key. Press  $\frac{\text{SET}}{0}$  or the PTT after making your selection. *Note:* This setting only affects audio when an earphone (or speaker-mic) is plugged in to the **EAR** jack (disabling the internal speaker).

## Transmitting

Press **[M]** → **[LOW]** once or twice, so that "LOW" appears at the top of the appropriate channel display, to select low power output (see box).

To transmit, wait until the channel is clear (**BUSY/TX** LED off), then squeeze the PTT switch on the side of the transceiver while speaking into the microphone (near the bottom right of the front panel). During transmission the appropriate VHF or UHF **BUSY/TX** indicator glows red, and the

corresponding bargraph shows relative transmitter power output. Release the PTT switch to receive.

If using a European version, press the upper ridge of the rubber pad on the left side (just above the PTT switch) to transmit a 1750-Hz Burst Tone to access repeaters that require it.

If you need more power to maintain communications, you can select another power setting as described in the box. However, we recommend using the lowest power level necessary to maintain communication, so as to maximize battery life and minimize possible interference to other stations.

## Repeater Splits

The FT-530 offers three methods to set up split transmit/receive operation for repeaters: manual, automatic and independently-stored tx/rx frequencies. Both manual and automatic methods shift the transmit frequency above or below the receive frequency by a programmable offset, preset at the factory to 600 kHz (VHF), or 1.6, 5 or 7.6 MHz (UHF). Note that only one offset, affecting all split channels, can be used with the manual and automatic methods. So when you want to store

### Caution!

Avoid transmitting at high power (5 W) for extended periods of time to prevent overheating the radio (especially during 13.8 VDC operation). A sensor in the FT-530 monitors internal temperature and automatically reduces transmit power to protect your radio if excessive temperatures are reached.

If this occurs, a blinking "LOW" message will be displayed. You should stop transmitting at this time and let the unit cool down. Continued transmission will cause the protective feature to inhibit transmission completely to protect the radio until it has cooled down sufficiently.

other offsets, such as frequencies of repeaters with non-standard splits, use the independent transmit frequency method instead. This is described later under *Storing Independent Transmit Frequencies*.

To activate the standard shift manually, just press **[M]** → **[RPT]** for minus shift, and press **[RPT]** again for plus shift, and again to return to simplex. A small "-" or "+" sign appears near the top right of the appropriate channel display to indicate the current shift direction, when activated.

**Example:** To operate through a 146.34/146.94 MHz repeater (substitute another pair if this is not used in your area):

- Tune the display to 146.94 MHz (to receive on the output frequency).
- Press **[M]** → **[RPT]** once. A "-" should appear at the top of the display (if not, press **[RPT]** again until it does).
- When the channel is clear, press the PTT switch and send your callsign. The display shifts to 146.34 MHz while you transmit.

Of course this example only works if the offset is set to 600 kHz, as supplied from the factory. You can change it as described next.

With repeater split activated, you can temporarily reverse transmit and receive frequencies by pressing **[M]** → **[REVERSE]**. You can use this to check the transmit frequency without transmitting, and to check the strength of signals on a repeater uplink frequency (to see if you can work them direct). The repeater shift sign blinks while reverse split is selected. Press **[M]** → **[REVERSE]** again to return to the normal shift direction.

### Squelch Override/Repeater Input Monitor Button

In non-European versions, if you often need to monitor the input frequency of a repeater, you can configure the squelch override button (the ridge in the rubber cover above the PTT button) to change to the repeater input frequency (your transmit frequency) while it also opens the squelch.

Press **[M]** → **[SET]** → **[REVERSE]**. "rE ON" indicates the feature is enabled, and pressing **[REVERSE]** turns it off again "rE OFF". Press **[SET]** or the PTT to save the setting and return the display to normal. While the squelch override switch is depressed, reception shifts to the repeater input and the repeater offset indicator "+/-" in the display will blink.

### Setting Standard Repeater Offset

As already mentioned, VHF repeater offset is preset to 600 kHz, and UHF to 1.6, 5 or 7.6 MHz. If you need to change the offset, first read the following steps, and then try them:

- Press **(EM)** → **(SET 0)** → **(RPT 6)** to display the current offset in MHz, to three decimal places.
- Select the desired offset with the **DIAL** knob or arrow keys. Resolution is 50 kHz.
- Press the PTT to return to normal display.

You probably want to keep the repeater offset programmed to the most commonly used split in your area. If you're not sure what that is, leave it set to the default.

#### Automatic Repeater Shift

The ARS (Automatic Repeater Shift) feature in the FT-530 activates repeater offset automatically

whenever you tune to the standard repeater sub-band. With this feature enabled, a small “-” or “+” at upper center of the display indicates that repeater shift is active (without your having to activate repeater shift manually), and closing the PTT switch changes to the (shifted) transmit frequency. The subband range over which ARS operates is determined by the version of your set, as shown below.

The ARS function is disabled at the factory. To enable it:

- Press **(EM)** → **(SET 0)** → **(RPT 6)** to display the ARS status (along with the repeater shift offset) in place of the primary frequency. An “A” appears to the left of the shift offset number when ARS is enabled.
- Now you can press **(EM)** (alone) to toggle ARS on and off.

### Automatic Repeater Shift - Repeater Subbands

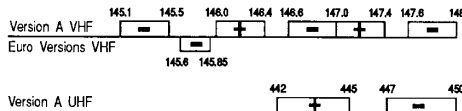

- Press **(RPT 6)** to return the display to the operating frequency.

As already mentioned, you can use the manual shift method (**(EM)** → **(RPT 6)**) at any time to select a new shift state, whether ARS is activated or not. However, if you change frequency with ARS activated, manual repeater shift selections are canceled.

#### Intelligent Band Selection

During dual receive operation, you can have the IBS function automatically toggle the receiver channels, so that whenever a station with whom you want to talk calls (on either receiving channel), your transmissions will always be on the right band and frequency.

To enable IBS:

- Press **(EM)** → **(SET 0)** → **(BAND ALT)**. “IBS” appears near the center of the display to indicate the function is activate. Press **(SET 0)** to return the display to the operating frequency.

During IBS operation, when a signal appears in the sub channel, a blinking “▶” appears to the left of the sub channel display. If you then press the PTT switch, that channel becomes the main (trans-

### Cross-Band Repeat Function

Your FT-530 can be set to operate as a cross-band repeater. Any signals received on the selected VHF frequency will be automatically and simultaneously re-transmitted on the UHF channel (and vice-versa). Before using this feature, *choose your frequency pair carefully!*

To enable this feature, press and hold the **(RPT 6)** key while powering on the radio. A “r” will appear in the memory box of both displays, along with “**LOW T SQ**” indicating the feature is enabled. Features such as tone encode/decode can still be disabled/enabled as before.

*One note of caution;* the tx duty cycle may be much greater than normal operation, therefore be careful to always select **low** tx power (on both VHF and UHF) when using this feature to prevent overheating or possible damaging your radio.

To return the radio to normal operation, simply turn the radio off then on again (you will have to clear the tone encode/decode and power selections from the cross-band repeater settings).

*Use of this function depends on laws and regulations where you live, and may be illegal in some countries. Check in your particular region before using!*

m  
aξ  
  
re  
ju  
(v  
th  
th  
  
S  
  
cl  
c:  
o  
(t  
sl  
L  
b  
P  
T  
[  
  
[

mitting) channel. Release the PTT and then press it again to talk.

After you have finished your QSO, you can revert to the other channel using the **BAND/ALT** key, or just wait for a new station. If a signal appears on (what was) the main channel, IBS will detect it and the blinking "▶" will shift again. Another touch of the PTT and you're ready for your next QSO!

### Simple Memory Storage

The FT-530 offers 41 programmable memory channels, labelled 1 through 38, L, U and C. Each can store separate receive and transmit frequencies or repeater shift, and CTCSS tone data. Memory C (the CALL channel memory) can be recalled instantly by the **CALL/DTMF** button at the left, and memories L and U can be used to store programmable sub-band limits, described later, in addition to general purpose operation.

To store a frequency in memory:

- Select the desired frequency (and repeater split manually, if desired) in the VFO mode as already described.
- Press and hold **(EM)** for ½-second (until a second beep sounds). A memory number or letter ap-

pears blinking in the memory box for the selected band.

- Within five seconds of pressing **(EM)** turn the **DIAL** or press **MHz** **(▲)** or **MHz** **(▼)** to select the desired memory for storage. If you select one that was already being used, it will be overwritten with new data in the next step.
- Press **(EM)** once more momentarily to store the displayed data into the selected memory. The memory label will stop blinking for a second, and then disappear as operation continues in the VFO mode.

If you timed out, nothing new will have been stored in the memory. Simply start again.

**Example:** Store the 146.34/146.94 repeater data in memory 5.

- First perform the steps in the example on page 22 to set up the desired frequency and offset on the VFO.
- Press and hold **(EM)** for ½-second to display the memory label (blinking) in the memory box, then do the next step within 5 seconds.
- Turn the selector knob or press the arrow keys, if necessary, so that "5" (the memory number to store) blinks in the memory box.

- Press **(EM)** again, momentarily. That's it. The VFO data has been stored in memory 5, and you are left operating on the VFO.

To confirm that this worked, turn the **DIAL** to change the VFO frequency (to anything new), then press **SKIP/MR** to change from VFO to memory mode. The numeral 5 should appear in the memory box, and 146.94 (the receive frequency) should appear on the display. As mentioned before, you can press **(EM)** → **CLOCK/REV** to confirm the transmit frequency of 146.34 MHz.

You can use any memory (except C, the CALL channel) with the same result. Memory C requires a slightly different procedure. Notice that pressing **SKIP/MR** from the VFO mode always recalls the *last stored or used* memory.

### Recalling Memories

In confirming the results of the last example, we used **SKIP/MR** to change from the VFO mode to the memories after they were stored. The memory label appears in the memory box at the upper left corner of the channel display whenever operating on a memory.

When more than one memory has been stored, you can select a memory for operation with the

selector knob, **MHz** **(▲)** and **MHz** **(▼)** keys, or by direct keypad access. If you use the arrow keys, press and release the key for each memory: if you hold the key down for ½-second, memory scanning will start. In any case, only prestored memories are displayed: empty memories are skipped. For direct access, simply enter the number of the memory channel you want, followed by **SKIP/MR**.

**Example:** to access memory channel 20, press **T SET** **(2)** → **SET** **(0)** → **SKIP/MR**.

To exit the memories and return to the last-used VFO, press **PRI/VFO**.

### Call Channel Memory

Although invisible to the memory recall methods just described, the CALL channel memory can be instantly recalled by the **CALL/DTMF** button: "C" appears in the memory box. The factory default for the CALL channel memory is the bottom edge of the band. You can reprogram it with any frequency and repeater state, or even a separate transmit frequency.

To store the current VFO frequency/repeater state in the CALL channel memory, hold **(EM)** for ½-second to display something in the memory box, then press **CALL/DTMF**. To store a separate transmit



frequency in the CALL channel, after storing the receive frequency, tune the VFO to the transmit frequency and repeat the above, but this time *holding the PTT switch while you press* **CALL** **DTMF**.

#### Storing Independent Transmit Frequencies

All memories can store an independent transmit frequency, for operation on repeaters with non-standard shift. To do this:

- Store the receive frequency using the method already described under *Simple Memory Storage* (it doesn't matter if a repeater offset is active).
- Tune to the desired transmit frequency.
- Press and hold **MEM** for 1/2-second to display a label in the memory box again.
- Press and *hold* the PTT switch while pressing **MEM** once more momentarily (this does not key the transmitter).

Whenever you recall a separate transmit frequency memory, “- +” appear together near the top center of the display. Again, you can press **MEM** → **CHG** to display the transmit frequency, and the shift symbols will blink. You can also press **MEM** → **PPT** **6** to cancel repeater shift (temporarily, until you change channels).

After storing a memory with a separate transmit frequency, if you rewrite the receive frequency in the same memory, the separate transmit frequency is deleted.

#### Memory Tuning

While receiving on a recalled memory, you can retune it and change other memorized settings (like repeater shift) by first pressing **SKIP** **MR**. A line of four tiny arrowheads (“>>>>”) appears under the memory label in the memory box, and you can tune in the same ways as described before (including 1-MHz steps). You can store the new frequency and settings in the current, or another memory. Just press and hold **MEM** for 1/2-second, select the new memory (if desired), and press **MEM** again momentarily. Operation remains on the (new) memory as the old memory reverts to its original state.

After re-tuning a memory, if you don't want to save your changes, just press **SKIP** **MR** to return to the original memory data.

#### Masking Memories

As already mentioned, storing data into a memory overwrites previously stored data. However, if you regularly move from one area to another, you

31

may want to use different memories in different places or at different times. With the FT-530, you can choose to make available different sets of memories without having to rewrite them from scratch. This is done by masking certain memories so that they are hidden from operation, and unmasking them only when desired.

To mask a memory,

- Recall the memory to be masked.
- Press and hold **MEM** for 1/2-second (until the memory label blinks).
- Press **SKIP** **MR**. This causes the display to change to the next lower (stored) memory, and the previously selected memory to be no longer selectable manually, or by scanning (described later).

To unmask a hidden memory for operation,

- Recall any memory.
- Press and hold **MEM** for 1/2-second (until the memory label blinks).
- With the selector knob or arrow keys, select the memory number to be restored.
- Press **SKIP** **MR** (not **MEM**!).

When you have hidden some memories, be careful not to overwrite them accidentally. If you

do, you will not be able to recover the previous contents.

#### Scanning

Before starting the scanner, make sure the **SQL** control is set to squelch off the noise on a clear channel. You start and stop scanning with the **MHz** **▲** or **MHz** **▼** key. Just press and hold either key for

#### Scan Resume Mode Selection

You have a choice of two scan-resume modes: either *Pause* mode, in which the scanner pauses for as long as the carrier keeps the squelch open; or the *5-second* mode, in which the scanner pauses for five seconds and then resumes scanning whether the signal is still present or not. The 5-second mode is the factory default.

To display the scan-resume mode, press **MEM** → **STEP** **7**. A small “P” or “5” in the memory box indicates the current mode. Press **MEM** again to toggle the mode, and **STEP** **7** again to return to normal display.

more than 1/2-second to start the scanner. If the transceiver is in the VFO or memory tune mode, band scanning will result. Otherwise, in normal memory mode, only the memories will be scanned.

The scanner pauses when a signal opens the squelch, and the decimal point on the display blinks. When band scanning, a double beep will sound each time the scanner reaches the band edge, unless you have disabled the beeper (**EM**) → **TSET** (2) → **EM** → **TSET** (2). Scanning resumes according to how you set the scan resume mode, described in the following box.

You can stop the scanner manually by pressing the PTT switch, **MHz** (▲) or **MHz** (▼) key, which will leave operation on the current frequency. Scanning is also halted by **SKIP** (**MR**), **PRI** (**VFO**) or **CALL** (**DTMF**), but operation shifts to the respective new frequency in these cases.

### Memory Skip Scanning

When you have some very active channels stored in memories you may wish to skip them when scanning, but still have them available for manual selection. You can mark a memory to be skipped by pressing **EM** → **SKIP** (**MR**) while receiving

on the memory. A small "◀" just outside the right of the memory box indicates that this memory will be skipped during scanning (although you can still recall it manually).

To undo the scan-skip state of a memory, just repeat the steps you took to disable it: select the memory manually, and press **EM** → **SKIP** (**MR**).

### Programmable Memory Scan

Besides band and memory scanning, the FT-530 can be set to tune or scan only the frequencies between two frequency limits of your choice (with the selected channel steps). These limits are stored in the special memories labelled *L* (lower) and *U* (upper):

- Store the lower edge of the desired scanning range in memory *L*, and the upper edge in memory *U*.
- With either memory *U* or *L* recalled, press **SKIP** (**MR**) to enable memory tuning, as described previously (">>>>" must be visible below the memory box). The frequencies stored in memories *L* and *U* now limit your tuning and scanning range to the resulting subband. If either ARS or manual repeater shift is activated, repeater offset is applied automatically when you transmit (even

33

if the resulting transmit frequency is outside the subband limits).

**Note:** The frequency resolution of subband limits is 100 kHz, although the channel resolution of memories *L* and *U* is the selected channel step size. Therefore the actual subband limits are the frequencies stored in these memories *rounded down* to the nearest 100 kHz. Since the memories themselves are not limited to a specific frequency, you can still use them for other purposes on any frequency within the 100-kHz range above the intended subband limit.

**Example:** To limit reception to 145.0 ~ 145.9 MHz

- Tune a VFO to *any channel between 145.000 and 145.095 MHz*.
- Hold **EM** for 1/2-second, tune the selector knob so that *L* appears in the memory box, and then press **EM** again momentarily. The displayed frequency is now stored to provide a lower subband limit of 145.000 MHz.
- Retune the VFO to any channel between 145.900 and 145.995 MHz.
- Repeat the second step, selecting *U* in the memory box. This stores the effective upper subband limit of 145.900 MHz.

34

- Press **SKIP** (**MR**) to change to memory operation, and **SKIP** (**MR**) again to activate the 145.000 ~ 145.900 subband limits for tuning and scanning. Note that when scanning the subband, as with band scanning, a double beep sounds each time the scanner reaches the subband edge, unless you have disabled the beeper (**EM**) → **TSET** (2) → **EM** → **TSET** (2).

To release subband limits press **SKIP** (**MR**) to return to memory operation, **PRI** (**VFO**) to return to a VFO, or **CALL** (**DTMF**) to switch to the **CALL** channel.

Once the *L* and *U* memories are stored you can reactivate the subband just by recalling either memory and pressing **SKIP** (**MR**) again. However, you cannot activate the subband if either of these memories is marked for skip-scanning, or masked (hidden).

### Priority Channel Monitoring

The priority function automatically checks for activity on a memory every five seconds while operating on a VFO or other memories. When the receiver detects a signal on the priority memory, operation automatically shifts to that memory while the signal is present (plus a few seconds). If you transmit while paused on the priority mem-

ory

on

To

ev  
to  
ch

me

mi

rie

ch

pe

sw

st

ap

wi

bli

ory, priority monitoring ceases and operation stays on the priority memory.

To set up priority monitoring:

- Preset the squelch, and store the frequency to be monitored in a memory (this must be memory 1 if you will be operating on other memories during priority monitoring).
- Press **PRI** **(VFO)** to operate in the VFO mode, or else select the memory you want to operate on, and then press **(M)** → **PRI** **(VFO)**.

A "P" appears in the memory box, and about every five seconds the displayed frequency shifts to the priority memory briefly while the receiver checks for a signal.

As long as no signal appears on the priority memory to open the squelch, you can tune, transmit and receive on the VFO, or select other memories (memory labels are displayed only while changing). If a station you wish to talk with appears on the priority memory, press the PTT switch momentarily while receiving their signal, to stop priority checking. Otherwise, when a signal appears on the priority memory, priority checking will pause and the decimal on the display will blink. Priority monitoring will resume according

to how you set the scan-resume mode — either after a 5-second pause, or after the carrier drops. To cancel priority monitoring manually, press **PRI** **(VFO)**.

Note that you can use any memory (besides memory 1) as a priority channel in the above procedure when you are going to be operating in VFO mode. You cannot, however, switch VFOs, or between memory and VFO operation, without first canceling priority monitoring (pressing **SKIP** **(MR)** or **PRI** **(VFO)** cancels priority monitoring).

**AM Receive**

Your FT-530 has an AM detector that can be enabled on the VHF receiver to permit reception of amplitude modulated signals (useful for air-band reception in versions with extended receiver coverage). To turn it on:

Press **(M)** → **SET** **(0)** → **(M)** → **PRI** **(VFO)**, ("A3 ON" will appear), then press **SET** **(0)** or the PTT. This setting affects all reception on the VHF receiver, so *don't forget to turn it off* for FM reception by repeating the above sequence ("A3 OFF").

**CTCSS Operation**

The FT-530 can be used to access repeaters that require a CTCSS (continuous, subaudible) tone, and to silently monitor for calls on busy channels. The encode ("T") function superimposes a subaudible tone (at a frequency too low to be heard) on the transmitted carrier. The decode ("TSQ" — tone squelch) function monitors receiver audio through a narrow filter at the same subaudible frequency, keeping the squelch closed until you receive a matching tone.

To check or set the current CTCSS tone frequency, press **(M)** → **TSET** **(2)** to see the tone frequency displayed in Hz. To change the selected tone frequency, turn the DIAL selector or press **MHz** **(▲)** or **MHz** **(▼)** until the display shows the tone frequency you require (the display will step through the standard EIA tones, listed in the following table). Press **TSET** **(2)** again alone to return to the operating frequency display when the desired tone frequency is displayed.

To activate CTCSS functions press **(M)** → **tone** **(1)** when the operating frequency is displayed. With one press, "T" (encode) appears at the top of the channel display and the tone generator is activated for transmission on that channel (if VHF, it must be

at the left, and if UHF, at the right). Press **(M)** → **tone** **(1)** again (or just **tone** **(1)** if the alternate key functions are still active) and both "T" and "SQ" (decode) will be displayed together as the tone squelch system is activated for both transmit and receive (only incoming signals "encoded" with the matching tone frequency open the squelch).

Pressing **(M)** → **tone** **(1)** once more turns off tone squelch features.

You can set a different CTCSS tone (and encode/decode state) in each VFO (A and B) on each band, as well as in each memory, just as you would

CTCSS Tone Frequencies (Hz)			
67.0	94.8	131.8	186.2
69.3	97.4	136.5	192.8
71.9	100.0	141.3	203.5
74.4	103.5	146.2	210.7
77.0	107.2	151.4	218.1
79.7	110.9	156.7	225.7
82.5	114.8	162.2	233.6
85.4	118.8	167.9	241.8
88.5	123.0	173.8	250.3
91.5	127.3	179.9	—

enter or store an operating frequency. To change the tone or state stored in a memory, just recall it, reset the tone frequency or function, and store the memory again (press and hold **(M)** for 1/2-second, release it, and press it again momentarily). If you activate CTCSS on one of the subband limit memories, it will be active when *that* memory is used to start subband operation.

### CTCSS Tone Scanning

If you hear signals which you suspect (or know) are using CTCSS, but you don't know what tone frequency is being used, you can activate CTCSS scanning to determine the frequency of the tone(s). To enable CTCSS scanning, press **(M)** → **(TSET 2)** → **(M)** → **(TSET 2)** and listen for the resulting beep(s). If you hear one low-pitched beep, CTCSS scanning is enabled. If you a high-low beep sequence, press **(TSET 2)** again while **(M)** is still at the top of the display (or else press **(M)** → **(TSET 2)** if it is not). In either case, press the PTT when done.

Once CTCSS scanning is enabled, you can activate it on the current channel frequency:

- Activate CTCSS Tone Squelch (**(M)** → **(TONE 1)** and then **(TONE 1)** again, if necessary, until "T SQ" is displayed).

When the CTCSS Bell feature is enabled, "▼" appears above the 10's-of-MHz digit on the display. When you receive a matching CTCSS tone this bell blinks and a ringer sounds to get your attention. Even if you do not hear the ringer, you can still tell if someone called, by looking at the display (the ▼ continues flashing until you reset it, or turn it off). You cannot tell, however, who called. That requires the DTMF Paging mode, described later.

To activate the CTCSS Bell:

- Tune to the desired frequency.
- Select a CTCSS tone frequency (**(M)** → **(TSET 2)**) as described starting on page 36, if you have not already.
- When you expect to receive calls from stations using tone squelch (decoding, or CTCSS Bell), activate tone squelch encode/decode ("T SQ") operation as described above, so you will not miss calls when you turn off the CTCSS Bell later to reply.
- Press **(CODE PAGE)** four times to select the CTCSS Bell mode. This cycles through the following paging mode/displays:

- Press **(M)** → **(TSET 2)** to display CTCSS tone frequency.
- Press and hold **(MHz ▲)** or **(MHz ▼)** for 1/2 second to begin scanning.

The scanning speed is very rapid when no signal is present, and slows down to several tones/second when a signal appears, as the signal is checked for a CTCSS tone. When the scanner matches the tone, as shown on the display, scanning pauses as the decimal on the display blinks. Press the PTT to stop CTCSS scanning at this point, and the displayed tone will remain selected. Otherwise, when the received carrier drops, CTCSS scanning will resume until another signal is received, or until you press the PTT to terminate CTCSS scanning (no transmission will occur).

Press **(TSET 2)** to return to the frequency display. Now when you transmit or store a memory, the scanned tone will be used.

### "CTCSS Bell" Paging

CTCSS Bell operation is actually an extension of the CTCSS encode/decode function already described: incoming subaudible tones open the squelch. Paging adds a display icon and audible ringer to alert you when someone calls.

- DTMF paging ("PAGE" displayed below the channel frequency).
- DTMF "Trigger" paging ("PAGE" displayed, and "☞" at the upper right of the channel frequency),
- DTMF tone-coded squelch ("CODE" displayed at the bottom).
- CTCSS "Bell" (▼ displayed), and
- No paging (none of the above symbols).

Now, all incoming calls without a matching CTCSS tone will be ignored by your receiver. Any call received with the matching CTCSS tone will cause the ▼ to blink and the transceiver to ring as the squelch opens while the caller transmits. The ▼ continues to blink until you manually reset it (by pressing the PTT switch to transmit, retuning, or pressing **(SKIP MF)** or **(PRI VFO)** to change channels). Note that other stations do not need to be using the CTCSS Bell function to call you: they can use normal CTCSS encode-only (or encode/decode) functions of their transceiver.

When you reply after a CTCSS Bell call, you will probably want to turn off the CTCSS Bell function, since otherwise the transceiver rings every time your squelch opens. Press **(CODE PAGE)** once to turn it off.

The CTCSS Bell feature is enabled or disabled for each receiver independently (regardless of VFO or memory selection).

### DTMF Paging & Code Squelch

The FT-530 includes a DTMF tone encoder/decoder and a dedicated microprocessor providing paging and selective calling features using DTMF tones. This allows you to place a call to a specific station or group, and to receive calls directed only to you or groups of your choice.

The paging and code squelch systems use 3-digit numeric codes (000 ~ 999), transmitted as DTMF (Dual-Tone, Multi-Frequency) tone pairs. There are eight Code Memories numbered 0 ~ 7 which store 3-digit DTMF paging codes (entirely independent of the 41 channel memories, bands and VFOs). DTMF Code settings apply to both bands and receiving channels, regardless of operating frequency or memory/VFO selection.

In typical applications, your receiver remains silent until it receives three DTMF digits which match those stored in one of its code memories. Then the squelch opens so the caller is heard, and in the paging mode, the ringer can be set so the transceiver also rings like a telephone (see the box

on the previous page). When you close the PTT to transmit, the same three prestored DTMF code digits are transmitted automatically. In the paging mode, three more DTMF digits are sent, representing the 3-digit identification code of the transmitting station.

Like the CTCSS Bell system described previously, DTMF paging and code squelch functions are selected by pressing **CODE PAGE**. Either "PAGE" or "CODE" appears on the display when DTMF paging or code squelch is activated, respectively. Details of the code squelch and paging modes are provided next.

#### DTMF Code Squelch

The code squelch mode is very simple: all stations communicate using the same 3-digit DTMF sequence, sent automatically by the FT-530 at the start of every transmission. Your receiver normally remains silent to any signals that are not prefixed by your selected 3-digit code. When you receive the matching tone sequence, your squelch opens and stays open until a few seconds after the end of their transmission. For added privacy, the 999 possible 3-digit DTMF codes provide added versatility over standard CTCSS tone squelch operation.

st  
or  
of  
pa  
al  
sp  
m  
  
D  
a  
in  
th  
6)  
D  
  
si  
d  
y  
ri  
C  
p  
w  
si

40

Before using DTMF code squelch, you must first store and then manually select the one Code Memory holding the 3-digit DTMF code required to open your squelch (as described on the following pages). Also, in this mode, Code Memories 1 ~ 6 always function the same — the distinctions and special settings described below for the paging mode do not apply.

In either code squelch or paging modes, any DTMF-equipped station can call you. They can use a DTMF keypad to send the three digits if you are in code squelch mode, or seven digits (actually, three digits—"star"—three digits, e.g. **1 2 3 \* 4 5 6**) if you are in paging mode.

#### DTMF Paging

In the DTMF paging mode, you can receive signals that are prefixed with any of up to six different 3-digit codes, according to the method you choose when programming the Code Memories. When you receive a paging call, the selected Code Memory changes automatically, and the display responds in one of two ways, depending on which of the following two methods you used to store the paging code:

#### Individual Codes

These are personal ID codes to identify each station uniquely. You store your ID in Code Memory 1, and up to five other Individual Codes of stations you call often, in Code Memories 2 ~ 6. When someone else transmits your Individual Code your transceiver automatically selects Code Memory 0, and the calling station's Individual Code is installed in that Code Memory so you can see who called (see the box on the page after next for code display options).

#### Group Codes

This type of code identifies a group of stations. You would generally share a Group Code with other club members or friends. When you receive a call with a Group Code the Code Memory number (2 ~ 6) in which you stored that 3-digit Group Code is selected and displayed automatically, so you can see which group has been called (if you have stored more than one).

Note that for a Group Code, the display does not show the ID and code of the caller, but those of the group instead. Code Memories 2 ~ 6 can be used to store either Individual Codes (for calling purposes only) or Group Codes (for both calling and receiving), as you desire.

With either type of page, the "PAGE" indicator starts blinking when a page is received, and the ringer sounds, if enabled. In the FT-530's Trigger Pager mode an expanding "☞" indicator will appear. The blinking indicators let you know if someone called while your attention was elsewhere.

Remember, the difference between code paging and code squelch operation is that with code squelch, you can only receive a call on the currently selected Code Memory, and the display does not change when a call is received. So for code squelch, as mentioned before, the Individual/Group distinction does not apply (although you must still store the 3-digit Code Memories).

#### DTMF Code Monitoring

Whenever a 3-digit DTMF code is received while either code squelch or DTMF paging is active, the code is automatically written into Code Memory 7. By selecting this Code Memory as described below, you can see what DTMF code was last heard, whether it opened your squelch or not.

#### Storing Code Memories

The first thing to do before using the paging or code squelch systems is to store your Individual Code in Code Memory 1.

- Press **(EM)** → **CODE PAGE** to enable the Code setting mode. The frequency display is replaced by a small Code Memory number at the left, and the corresponding 3-digit Code ("000" if not used before) at the right.



- Use the **DIAL** or up/down keys to select Code Memory 1 (this digit can be set to 0 ~ 7, with 0 and 7 being "read-only," and 2 ~ 6 programmable with group or other individual's IDs). Code Memory 1 is for your personal DTMF paging ID Code.
- Using the numeric keypad, enter the three digits (each 0 ~ 9) of the DTMF Code to store.
- Press **CODE PAGE** to return the display to the operating frequency.

Your ID Code is now stored in Code Memory 1. You can use the same procedure to store the Memory Codes of other individuals or groups in Code Memories 2 ~ 6, but with an additional feature: generally you store another station's ID Code so you can page them, but do not want to have your

transceiver ringing every time someone else calls them. On the other hand, you store group codes with the intention of receiving any pages to the group (so you want your squelch to open and the transceiver to ring, if paging).

#### Page Code Inhibit

During the Code Memory storage procedure described above, when storing Code Memories 2 ~ 6, you have an opportunity to decide whether your transceiver should respond to incoming paging calls on a particular Memory Code. After pressing **(EM)** → **CODE PAGE** to activate Code setting you can press the **(EM)** key to toggle DTMF squelch paging capability on and off. When on, that is, when the decoder is enabled to receive paging calls with this Code Memory, a tiny underbar "—" appears beneath the Code Memory digit.

If you are setting a Group Code, you want to have the underbar on, and if setting another station's Individual Code, you want it off. As already mentioned, this distinction does not apply to DTMF code-squelch-only (non-paging) operation — the underbar will have no effect.

Note that the underbar is displayed permanently on Code Memory 1, since this is your own ID (that you will always want to receive when

#### DTMF Code Display Options

Normally, the Code Memory number is displayed in place of the 100's-of-MHz frequency digit whenever DTMF Code Squelch, DTMF Paging, or Trigger Paging is enabled (the rest of the frequency digits remain as before). Also, the **MHz** and **MHz** keys rapidly select *Code Memories*, instead of tuning or scanning (**DIAL** operation remains unchanged).

If you want to scan while in these modes, you may prefer to enable the alternate Code Memory display feature, which displays DTMF Codes only after pressing **(EM)** → **CODE PAGE**, or receiving a page.

To toggle this alternate Code Memory display mode on/off, press **(EM)** → **SET 0** → **CODE PAGE**. Pressing **CODE PAGE**, again will toggle the feature on/off ("OPON" and "OPOFF" will reflect your selection). Press **SET 0** or the PTT to return to normal operation.

paging is activated). Also, the underbar never appears on Code Memory 0, since this is reserved for displaying a paging station's individual code.

Once you have stored your own ID Code in Code Memory 1, you can activate the paging or code squelch functions from the normal frequency display by pressing **CODE PAGE**. As mentioned earlier in the CTCSS Bell procedure, repeatedly pressing this key cycles through DTMF paging ("PAGE" displayed), Trigger pager ("PAGE" and "☞" displayed), DTMF code squelch ("CODE" displayed), CTCSS Bell paging (▼ displayed), and no paging (none of the above symbols).

#### DTMF Code Squelch Operation

As described earlier, with the DTMF code squelch activated ("CODE" displayed), your squelch will open when you receive the proper 3-digit DTMF ID Code according to the selected code memory. Likewise, each time you depress the PTT, the same selected 3-digit code is automatically sent to open the other station's DTMF code squelch.

#### Receiving a DTMF Page

With the DTMF Paging feature activated ("PAGE" displayed), any DTMF-equipped station can call you by sending your 3-digit code, followed by a

DTMF "star" (\*), and their 3-digit ID Code. Your transceiver will ring, "PAGE" will start blinking, and the code of the paging station (now in Code Memory 0) will be displayed.

If you press your PTT switch after receiving a page, the transceiver sends the other station's ID Code, a DTMF "star" (\*) followed by your own three-digit code all automatically, and then resets the pager to receive another call.

Unless you are using the Trigger Paging function (covered next), you may want to switch from paging to code squelch mode once contact is established. Just press **CODE PAGE** once, so that "CODE" appears. Either you or the other station will also have to select Code Memory 1, so that you will both be using the same DTMF code (either, but not both, must re-select their Code Memory). This can be

#### Paging "Err" Display

If a paging code is received from another station having your correct ID code (and the \*), but lacking their 3-digit ID, or if only a part of their ID code was received, your alert ringer will still sound. However, "Err" will be displayed indicating that the ID code of the other station could not be read.

44

done easily if the *Code Memory Display Option*, described in the box on page 43, is activated: just press **MHZ**.

With Code Squelch activated in this manner, you will hear three DTMF code digits transmitted when you press your PTT switch. These are the digits stored in the Code Memory currently selected (and displayed in place of the 100's-of-MHz digit if the Code Memory Display option is enabled), and they will open the squelch of the other station. Therefore, at the start of each transmission, you must wait a second or two after pressing the PTT switch for the DTMF code to be sent (you will hear it in your speaker).

When you finish your conversation, if you need to reactivate DTMF Code Paging, press **CODE PAGE** three times until "PAGE" is again displayed.

#### Trigger Pager

This feature can be used exclusively between Yaesu FT-530 transceivers, to avoid the need to change to Code Squelch mode after a page.

To activate this feature, press **CODE PAGE**, repeatedly if necessary, so that "PAGE" and "☞" appear in the display. As before, when a page is received, "PAGE" blinks and an "expanding ☞" appears. How-

#### DTMF Code Delay

When calling other stations with DTMF paging or code squelch, particularly through repeaters, you may find some are unable to receive your calls. This can be caused by their receiver squelch not opening fast enough (after receiving your carrier) to allow all of the DTMF digits to be received and decoded. To correct this problem, you can set a longer delay (750 ms) between the time your transmitter is activated and the time that the first DTMF digit is transmitted.

Press **(EM)** → **SET** → **0** → **1** and then **1** again, if desired, to select either 450 or 750 ms delay. Press the PTT to return the display to normal.

ever, unlike normal DTMF paging, if the other station is also using an FT-530, communications can begin just by acknowledging the page (pressing the PTT), and talking *within three seconds* after the DTMF code is sent. The pager resets to receive a new call as soon as either station fails to respond to the other within three seconds.

45

### Auto Page Acknowledgment

With the Page mode active, you can respond to a page manually (by pressing the PTT), or you can set the FT-530 to respond automatically ("transpond"), by sending back their individual paging code followed by your own. This immediately informs the calling station that their page was successful. Using this feature in combination with the Trigger Paging mode allows virtually hands-free automatic paging operation (the page is automatically acknowledged and the squelch is opened for voice communication).

To enable this feature, press **(EM)** → **(SET 0)** → **(XFER 9)** "PAON" will appear, and pressing **(XFER 9)** again will disable it, ("PAOFF" will be displayed). Press **(SET 0)** to return the display to normal.

### DTMF Autodial Memories

The FT-530 provides ten memories, numbered 0 through 9, for storage of DTMF tone sequences of up to 15 digits each, to be used for remote DTMF control sequences or telephone numbers for autopatching systems. Some of these memories can also be dedicated to store ringer melodies (covered later).

46

Downloaded by  
RadioAmateur.EU

key in the numbers of the DTMF sequence you want to store. As you do so, the serial digit number in the center of the display increments as the entered code is displayed at the right.

*Note! When entering new DTMF codes, the serial digit number on the display will be that of the next digit to be stored - not the serial number of the digit displayed at the right!*

If you make a mistake press the PTT switch to cancel your entries, and repeat this step (all digits must be re-entered).

- If you are storing fewer than 15 digits, press **(CALL DTMF)** briefly to terminate entry (if storing 15 digits, entry terminates automatically after the last digit). To replay the stored codes in the loudspeaker and on the display, press the numbered key corresponding to the memory number stored. You can also press **(MHz ▲)** and **(MHz ▼)** to display each digit manually (with the actual digit number in the center of the display, and its DTMF code at the right).
- Turn the **DIAL** knob to select another DTMF memory to store, if desired, and repeat the last two steps.
- Press **(CALL DTMF)** to return to the frequency display.

To use the DTMF memory features a special mode must be activated by pressing **(EM)** → **(CALL DTMF)**. A "Ⓜ" is displayed below the rightmost frequency digit when this mode is active (the same keys also deactivate the mode).

To store a DTMF memory:

- Press **(EM)** → **(CALL DTMF)**, if necessary, to display "Ⓜ"
- Press and hold **(EM)** for 1/2-second (until the second beep sounds). A flashing number appears in the memory box, indicating the selected **DTMF memory** number.
- Within 5 seconds of the last step, press a numbered key corresponding to the DTMF memory number you want to store. The display changes to that shown below.
- Again press and hold **(EM)** for 1/2-second (the DTMF memory number begins to blink), then

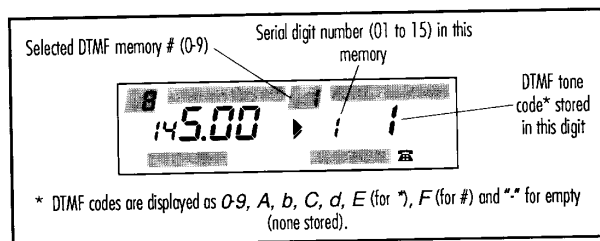

To check the contents of any or all DTMF memories while "Ⓜ" is displayed, just hold **(EM)** for 1/2-second and press any numbered key (to change the display to DTMF memories), then turn the **DIAL** knob to select the DTMF memory number in the memory box at the upper left, and use the arrow keys to display each digit.

To recall a stored DTMF memory on the air, first make sure the DTMF memory mode is activated ("Ⓜ" displayed). Then close the PTT switch and press the number of the DTMF memory to transmit. Once the DTMF sequence has begun you may release the PTT (the transmitter stays keyed until the sequence is over).

If you do not have the required DTMF sequence stored in memory, press **(EM)** → **(CALL DTMF)**, if necessary, so that "Ⓜ" is no longer displayed, then enter the DTMF digits individually.

### Note!

When the DTMF memory mode is active, the keypad cannot be used to transmit individual DTMF codes. First turn the DTMF memory mode off by pressing **(EM)** → **(CALL DTMF)**, then enter the digits.



Several more features are available for optimizing and customizing DTMF operation, as described beginning under *DTMF Settings* on the next page.

### Ringer Settings

You can customize the ringer that alerts you to incoming calls during CTCSS Bell and DTMF Paging operation:

#### Continuous (Repeating) Ringer

The default ringer alerts you only once when you have received a page, after which the only indication that you have received a page is the blinking display. You can change this setting so that the ringer *continues sounding once a minute* until you respond. You would normally enable this if you expect to be out of hearing range of your radio from time to time, and don't want to miss an incoming page (or don't want to have to look at the radio's display every time you return).

Press  $\text{[EM]} \rightarrow \text{[SET 0]} \rightarrow \text{[EM]} \rightarrow \text{[CODE PAGE]}$ . "*cr ON*" will be displayed indicating continuous ringing is on. Press  $\text{[SET 0]}$  or the PTT to save the setting and return the display to normal. To return to a single ringer alert, repeat the above step ("*cr OFF*" will be displayed).

48

be played back as either DTMF pairs or musical tones (see: *DTMF Memory Playback*, below).

#### Disabling the Ringer

While the CTCSS Bell ringer cannot be disabled, you can change the on/off state or number of rings (1, 3 or 5) of the DTMF Pager ringer: press  $\text{[EM]} \rightarrow \text{[SET 0]} \rightarrow \text{[T SET 2]}$ , and if you like, press  $\text{[T SET 2]}$  again repeatedly to select display of "*Pc OFF, Pc 1, Pc 3* or *Pc 5*". Then press  $\text{[SET 0]}$  or the PTT switch to return to normal.

With the ringer enabled during DTMF Paging, every incoming call causes the ringer to sound. To prevent this, you can disable either the ringer (set to *OFF*) or switch to normal CTCSS tone squelch (*T SQ*) operation by pressing  $\text{[CODE PAGE]}$ .

### DTMF Settings

Following are a few alternate setting functions of the DTMF keypad that you can customize to your own preference.

#### Musical or DTMF Keypad "Beep"

Normally, pushing a key sounds a beep corresponding to a musical note. If you prefer, you can change the musical beeps to DTMF tones by pressing  $\text{[EM]} \rightarrow \text{[SET 0]} \rightarrow \text{[EM]} \rightarrow \text{[LOCK 5]}$ . "*b dt*" appears to

### Changing Ringer Melody

If the ringer is enabled, you can listen to the current ringer melody by pressing  $\text{[EM]} \rightarrow \text{[SET 0]} \rightarrow \text{[CALL DTMF]}$ . Press  $\text{[SET 0]}$  or the PTT switch to return to normal display. If you prefer different melodies, you can compose and enter *two* of your own (one for each receiving channel), so you will know from the melody which channel to reply on when monitoring both.

Your own melodies are stored in two DTMF autodialler memories (up to 15 digits/tones) in the same manner as programming a DTMF memory for autodialing (see the previous page). The VHF-band paging melody is stored in DTMF memory channel #2, and the UHF melody in channel #3.

After storing your ringer melodies, press  $\text{[EM]} \rightarrow \text{[SET 0]} \rightarrow \text{[EM]} \rightarrow \text{[CALL DTMF]}$ . "*Pc dt*" is displayed, indicating that DTMF channels 2 & 3 are being used for the ringer alert melodies instead of autodialler numbers. Press  $\text{[SET 0]}$  or the PTT to store the new setting and return to the operating display. To switch back to the default melody, repeat the above key sequence ("*Pc b*" will then be displayed), and press  $\text{[CALL DTMF]}$  to toggle between default and custom melodies. Note that your melodies can

confirm your selection. You can toggle back to the default beep by pressing the  $\text{[LOCK 5]}$  key again ("*b b*"). Pressing  $\text{[SET 0]}$  or the PTT switch saves your entry and returns the display to normal.

#### DTMF Memory Playback

Like the keypad beep selection above, the tones stored in the DTMF Autodialler memories can be played back using single-tone musical notes instead of DTMF tones. You will probably want to select the musical notes if you are using memories 2 & 3 for custom ringer alert melodies. Note, however, that while this setting is in effect, you cannot generate the DTMF tones needed for autodialing.

To change the memory tones, press  $\text{[EM]} \rightarrow \text{[SET 0]} \rightarrow \text{[EM]} \rightarrow \text{[SAVE 4]}$ . "*d b*" is displayed to confirm your selection. You can toggle back to the default beep by pressing  $\text{[SAVE 4]}$  again ("*d dt*"). Pressing  $\text{[SET 0]}$  or the PTT switch saves your entry and returns the display to normal.

#### DTMF Keypad Transmit Hang Time

When entering a string of DTMF digits, this feature keeps the transmitter keyed for 2 seconds after each key entry *without* having to keep the PTT depressed. This is convenient for repeater auto-patch operation when the number you are dialing

49

isn't stored in DTMF memory. It is enabled by pressing **[M]** → **[SET 0]** → **[M]** → **[TONE 1]**. "thON" appears, indicating the hang time is enabled. Pressing **[TONE 1]** again toggles the setting off ("thOFF" appears). Press **[SET 0]** or the PTT switch to save the setting and return the display to normal. To send a DTMF sequence, press the PTT initially, then release it while entering the DTMF key sequence (the transmitter unkeys 2 seconds after your last entry).

#### Fast DTMF Memory Playback

You can toggle the playback speed of audible tone sequences (DTMF or musical beeps, if enabled). Note that this speed selection affects all tone playback in the FT-530: Autodialer, Page Codes and all Ringer/Alerting Melodies. The default setting is 7.5 digits/second, which can be changed to 10 digits/second: press **[M]** → **[SET 0]** → **[M]** → **[CLOCK KEY]**. "ds 100" is displayed indicating a tone duration of 100 ms (fast playback). Press **[SET 0]** or the PTT to save the setting and return the display to normal. To return to slow playback, repeat the above step ("ds 150" will be displayed).

#### Disable Keypad Row & Column DTMF Output

As explained previously, each DTMF tone consists of a pair of audio frequencies generated simultaneously. Disabling a row or column keyboard output prevents one of the two required tones from being generated, effectively disabling the radio from performing functions requiring DTMF (autodialing, paging, repeater autopatching, remote control, etc.). This feature can be enabled if you want to generate a test tone of a specific frequency, or to add an extra degree of security to prevent unauthorized persons from using your radio to perform the above functions. However, for normal operation we recommend you not change these!

To disable row output press **[M]** → **[SET 0]** → **[M]** → **[VOX 8]**. "r OFF" will be displayed. Press **[SET 0]** or the PTT to save the setting. Repeat this step to turn the row output back on ("r on" displayed).

To disable column output press **[M]** → **[SET 0]** → **[M]** → **[XFER 9]**. "c OFF" will be displayed. Press **[SET 0]** or the PTT to save the setting. Repeat this step to turn the row output back on ("c on" displayed).

### Clock & Timer Functions

Your FT-530 has an internal 24-hour clock with alarm that can display the time with the touch of a key, and ring to remind you of an important sked (or wake you up)! In addition, a programmable timer can be set to turn your radio on and off at preset times.

#### Setting the Clock

The clock is displayed by pressing **[M]** → **[CLOCK KEY]**. To set the time, press **[M]** again. The display now shows the hours place and a flashing colon. Rotate the DIAL to set the correct hour (24-hour format). Next press the **[MHz]** key to select the minutes place, and use the DIAL in the same manner to set the correct minutes. If you made a mistake, or wish to return to the hours place, pressing **[MHz]** toggles between the hours and minutes place. After entering the correct time, press **[CLOCK KEY]** to begin time-keeping and return to the normal clock display. To turn off the clock display, press **[CLOCK KEY]**.

#### Setting the Auto On/Off Timers

Press **[M]** → **[CLOCK KEY]** as before to display the time, then press **[TONE 1]**. The display indications will be the same as when you set the time on the clock. Follow the same procedure as described above to set the

hours and minutes for the time you want the radio to turn itself on, then press **[M]**. The "ON" symbol appears in the lower right corner of the LCD to indicate the on-timer is activated, and pressing the **[M]** key at this point toggles the On-Timer on and off. Press **[CLOCK KEY]** to return the display to normal. The radio will now turn itself on at the preset time.

If you want your radio to also turn itself off at a preset time, the Off-Timer can be also be enabled. Using the same method as before, Press **[M]** → **[CLOCK KEY]** to display the time, then press **[TSET 2]** and set the time you want the radio to turn off. Press **[M]** to enable the Off-Timer, "OFF" will now be displayed along with the on timer indication ("ON OFF"). Press **[CLOCK KEY]** to return the display to normal. The radio will now turn itself off at the preset time.

#### Timer Alarm

Included with your FT-530's timer functions is an alarm beeper that can be set, for example, along with the On-Timer to alert you when your radio powers on. A snooze feature even resets the alarm for 3 minute intervals. To set the alarm press **[M]** → **[CLOCK KEY]** as before, then **[LOW 3]**. Set the alarm time, then press **[M]** to enable the timer. "(...)" will be displayed above the "ON OFF" timer indications. Press



**Note!**

Even though On/Off & Alarm times have been set, operation does not begin until the individual timers have been enabled, as indicated by the "☐" symbols in the lower right corner of the LCD. To override a timer that has turned off/on your radio, just press the orange **POWER** switch to take back control again.

 to return the display to normal. The alarm will now beep at the preset time.

After the alarm goes off, you can quiet and reset it by pressing the PTT switch, or press any key on the keypad to give yourself as many three minute snooze intervals as you like!

*Timer Memory*

If you would like to log the time of a QSO or some other important event, it can be stored into a unique timer memory. Press and hold the **(EM)** key until "1" blinks in the memory box, then press . That's it, the display will return to normal. To recall the stored time, press **(EM)** →  → **(SKIP MFR)** and then press  to return the display to normal.

Downloaded by  
RadioAmateur.EU

## Extending Battery Life

How long the batteries last between charges or replacement depends largely on your operating habits, and how you care for the battery pack (if using a Ni-Cd pack). The FT-530 offers a variety of ways to conserve battery power, and thus to extend the life of each charge. Knowing how to use these features can be critical in emergencies.

*APO (Automatic Power-Off)*

Obviously, turning the set off when not in use saves battery life, and can also prevent damage that might result to the batteries if they are over-discharged. The FT-530 provides the APO system to turn itself off after 10, 20 or 30 minutes of key inactivity. As shipped from the factory, APO is disabled, but you can easily activate it by pressing **(EM)** → **(SET 0)** → **(LOW 3)** and then **(LOW 3)** again repeatedly to choose the time-out time (in minutes). Then press the PTT or **(SET 0)** key to return the display to normal. When APO is activated, "APO" appears near the bottom right corner of the display, and a timer starts every time you press a key. If you don't press any keys for the selected time-out period, and as long as you are not scanning or priority monitoring, "APO" will begin blinking and if you have the key beeper activated (page 18), it will play a

melody (to let you know that it's about to turn off) about a minute before the transceiver turns itself off. If you don't press a key in that minute, the transceiver turns (almost) off — actually, everything is turned off except the display, which shows "OFF." After that, you must switch the transceiver off and back on for use. If you need to monitor for a long period, or if using an external DC supply, you can deactivate the APO feature by pressing the same keys as above, so the display shows "OFF."

**APO Warning Melody**

The factory default one-minute warning melody can be changed to one of *your own* composition. This plays back the tones you store in DTMF memory channel #1 (See *DTMF Autodial Memories*, page 46).

Press **(EM)** → **(SET 0)** → **(EM)** → **(LOW 3)**. "AP dt" appears, indicating the alternate melody will be read from DTMF memory 1. Pressing **(LOW 3)** toggles back to the default as "AP b" appears.

Press **(SET 0)** to save your selection and return the display to normal.

### Power Saving When Receiving

Monitoring with squelch closed requires about one third the power of listening to unsquelched noise, so you will naturally want to keep the squelch closed as much as possible. The FT-530 uses a new high-speed version of the Battery Saver system originated by Yaesu, reducing current drain by a factor of five during squelched monitoring. The Battery Saver turns off the receiver three seconds after the squelch closes, and then turns it on for 30 milliseconds periodically to check for incoming signals. When the Battery Saver is enabled, a small "SAVE" appears near the bottom right corner of the display, which blinks when the saver is functioning.

In the FT-530, you can select from eight sleep durations, from 10 ms to 1.28 seconds, or you can select the ABS (Automatic Battery Saving) function, which senses channel activity and dynamically selects a monitor/sleep ratio according to recent operating history.

The ABS mode is enabled as supplied from the factory. You can check or change the sleep duration or disable the Power Saver by pressing (M) → (SAVE 4), and then pressing one of numeric keys 1 through 9 to change the current (displayed) sleep duration.

54

tery life by reducing power output when the microprocessor determines it is not required, that is:

- when the transmitter is keyed but you are not speaking, and
- when a full-scale signal is sensed on the receive frequency (such as a repeater output).

TX Save is not enabled from the factory but can be turned on by pressing (M) → (SET 0) → (SAVE 4). The "ts on" message appears on the display. Pressing the (SAVE 4) key toggles this feature on/off ("ts OFF" displayed). Press (SET 0) or the PTT to return the display to normal. With TX Save enabled, "SAVE" blinks in the display during transmit.

Regardless of whether you use the TX Save feature or not, notice that the current drain of the L1 setting is about 40% of the Hi setting, so it is good to develop the habit of always using the lowest setting possible, switching to high power only when low power fails to get through. If you live in a location where high power is almost always needed, consider using a higher gain antenna instead of opting for high power (the effect on transmissions is the same). Make sure any external antenna is designed for 50 ohms impedance at the operating frequency.

Possible selections and their corresponding keys are shown in the table below.

Power Saver Sleep Ratios

Key	Sleep time (ms)	On:Off	Key	Sleep time (ms)	On:Off
TONE 1	10	1: 0.33	RPT 6	320	1:10.67
T SET 2	20	1: 0.67	STEP 7	640	1:21.33
LOW 3	40	1: 1.33	VOX 8	1280	1:42.67
SAVE 4	80	1: 2.67	XFER 9	ABS	VARIABLE
LOCK 5	160	1: 5.33	SET 0	OFF	ALWAYS ON

### Transmitter Power & TX Save

One of the best operating habits is to always use the lowest transmitter power necessary to maintain reliable communications. As described on the box on page 23, the FT-530 offers a choice of four levels of power output: one Hi, and three low — L1, L2 and L3. On top of this, the FT-530 can reduce transmitter current drain further with its smart TX Save feature. This feature conserves bat-

### BUSY LED Disable

The BUSY function of the BUSY/TX LEDs is to help you set the squelch control, and to indicate when the channel is busy, so you don't transmit on top of other signals. However, each LED draws about 5 milliamperes when lit, and thus can contribute significantly to battery drain when monitoring active channels. If you need to preserve power in such circumstances, you can disable the BUSY function of one or both of the LEDs:

First select the main or sub channel, then press (M) → (SET 0) → (STEP 7). The selected BUSY/TX LED flashes while the "OFF" message is displayed, indicating the BUSY/TX LED for that band is disabled. Press (STEP 7) again if you want to reactivate the BUSY LED ("on" displayed). Press (SET 0) or the PTT to return to normal display. You can toggle the state of the BUSY LED at any time by pressing the same keys again.

### Beeper Disable

Like the BUSY LEDs, the keypad beeper draws several milliamperes when enabled, so you may want to disable it if you need to conserve power while using the keys a lot. Do this by pressing (M) → (T SET 2) → (M) → (T SET 2). To reactivate the beeper,

55

repeat this key sequence. A "b" in the memory box indicates the beeper is enabled.

### Selective Calling

Obviously, if the operating frequency is quiet the squelch does not open often and power drain is minimized, particularly if the Power Saver is active. Unfortunately, it is not always possible or practical to confine your activity to quiet frequencies. The DTMF selective calling (code squelch, and DTMF paging) features in the FT-530 can be used to essentially make a quiet channel out of an otherwise busy one. When either of these features is active, the squelch will only open (and the **BUSY/TX** LED light, if enabled) when a signal is prefixed by a 3-digit DTMF code that matches one you have stored in the DTMF Code Memories (see page 41). This can extend battery life considerably.

In cases where you may need to monitor many stations, or some that are not equipped with DTMF encoders but do have CTCSS, the Tone Squelch can also be used to make a quiet channel on a crowded frequency.

### Earphones & Speaker/Mics

Using the lowest possible volume setting minimizes current drain while receiving. You can hold

the transceiver up to your ear and reduce the volume to minimum, but it may be more convenient to use an earphone, speaker/mic or the MH-19A2B Earpiece/Mic, and keep the transceiver clipped to your belt, particularly in noisy environments.

### VOX Operation and Settings

If you want to have both hands free, use the YH-2 Headset and activate VOX (voice-actuated transmit/receive switching) by pressing **[EM]** → **[VOX 8]**, and then **[VOX 8]** again if you want to adjust the VOX gain (sensitivity). The display shows either "Hi" (for operating in a quiet environment) or "Lo" (if in a noisy environment). The display returns to normal a few seconds after you select the VOX state, and a small "V" appears near the bottom center of the display when VOX is enabled.

#### *Note!*

Your FT-530 is designed for VOX operation with the YH-2 headset. VOX will not function using the internal microphone, or with speaker/mics like the MH-12 A2B and MH-29A2B (because of audio feedback). In addition, VOX cannot be selected while operating in the Pager mode.

Press the same keys again (so that "OFF" is displayed) to turn the VOX off when not using the YH-2.

You can also select the VOX delay (how fast the transceiver returns to receive after you stop speaking), from 0.5, 1.0 or 1.5 seconds. Optimum delay depends on your speech characteristics, and should be set just long enough so the transmitter remains keyed between words. To adjust the VOX delay:

Press **[EM]** → **[SET 0]** → **[VOX 8]**, to display the current delay, and press **[VOX 8]** again to toggle through the choices. After selecting a delay, press **[SET 0]** to return the display to normal. You can experiment to determine the best setting.

### Battery Care

As the battery discharges, the voltage drop when transmitting increases. When battery voltage drops to around 5.5 volts, the display begins alternately flashing the voltage, indicating the batteries should be replaced or recharged. As battery voltage drops further, the indicator begins to blink, until transmission (and soon the controls) fails.

If using rechargeable batteries, switch the transceiver off as soon as the indicator begins to blink.

Leaving it on could over-discharge the cells and destroy the pack. On the other hand, recharging Ni-Cd batteries often with little use between charges can degrade the charge capacity and useful life of the cells. To avoid these problems, use the battery pack just until the low battery indicator comes on, and then immediately give the pack a full recharge. Since it is hard to know exactly when the charge will run out, you may want to carry an extra, fully-charged pack with you to avoid having operation interrupted.

## In Case Of Problems

Don't worry if you find FT-530 operation somewhat complicated at first. There are many more features than the display can indicate at one time, and most keys have more functions than are indicated by their labels. So it is not difficult to get lost, at least until you have had the chance to learn the various functions of the display and keys. This section provides some tips to help you navigate the various display and key modes.

If the display shows nothing at all, check the power switch, and if necessary, remove the battery pack and check that the contacts are clean. If all appears to be physically in order, recharge or replace the batteries.

The state of the display tells a lot (but not all) about the current state of operation. The display can take on a great many different states, but most of them are temporary and will time out after a few seconds, returning to the operating frequency. Exceptions are the displays for the "setting" mode, DTMF Code Memories and CTCSS tone frequency).

Fortunately, the display includes many symbols and function indicators to let you know what is going on as long as power is applied, so it is well

worthwhile to study the display diagram on page 8 carefully. For example, if the frequency display changes unexpectedly when you transmit (or if "Err" appears), check for a small "+" or "-" near the top center of the display, indicating repeater shift is enabled.

Attempting an illegal command will usually do nothing, and no beep will sound. However, nothing happens when you press a key for even legal commands if the keys are locked: check for "KL" (key lock) or "PL" (PTT lock) at the bottom left corner of the display. If you see one of these, press **(EM)** → **(LOCK 5)**, and keep pressing **(LOCK 5)** until the lock symbols are cleared.

If you still cannot enter data, check to see if either of the **BUSY/TX** LEDs is red, indicating the transmitter is activated. Releasing the PTT switch should return the set to receive. If not, switch the transceiver off, and then back on.

If the 100's-of-MHz digit is weird (that is, not 1) or behaves strangely when you try to tune, check for either "PAGE" or "CODE" at the left side of the display, indicating that DTMF paging or code squelch is active with the code memory display option. If so, press **(CODE PAGE)**, several times if necessary,

58

to clear these symbols and return the frequency display to normal.

If the display is almost completely blank, except for "F" in the memory box, you have entered the "setting" mode. Press the PTT switch to clear things to normal.

As a last resort, if you are unable to gain sensible control of the transceiver, reset the CPU as described below.

To avoid confusion resulting from inadvertent button presses, set the keypad lock on as described on page 20 if you leave the transceiver unattended while it is on. Remember to set the lock back off when you wish to enter data.

### Resetting the CPU

The FT-530 can be reset from the keypad to clear all settings, memories, channel step and repeater shifts to their factory defaults. Just press and hold both **(SKIP MF)** and **(PRI VFO)** together while turning the transceiver on.

### Memory Backup

Normally, a lithium cell inside the transceiver retains all settings and memories while power is off or disconnected. If this battery ever needs re-

placing, the transceiver will be found to have lost its memories, although it will still operate properly.

The illustration below shows the battery tray location on the front panel. To remove the cell, first ensure a charged battery pack is connected and the radio is turned on (so your memorized data is not lost), then simply use your thumb-nail or a small flat screwdriver to pry the tray from the transceiver body, and then slide it out of the radio. Note the polarity and fit of the cell, the positive flat side faces forward (toward the front of the radio). Only replace with a Panasonic Type CR1220 or equivalent, then slide the tray back into the transceiver until flush.

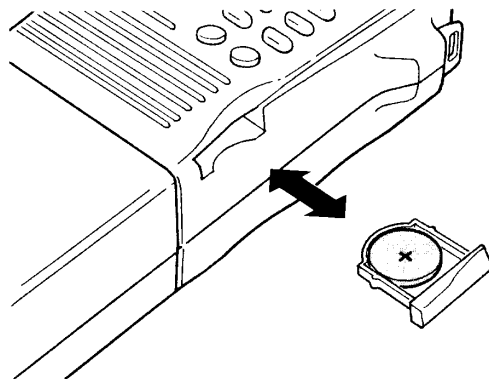

59

## Packet Setup

To use the FT-530 for packet, the power saver and VOX should be disabled.

The sleep periods used in power saving can cause packets to be missed, particularly if the sleep time exceeds 20 ms. To disable the power saver, press **(M)** → **SAVE** → **4** → **SET** → **0**.

Similarly, the VOX attack time (delay) can cause the first part of your outgoing packets to be cut, making your packets unreadable. If "V" is displayed to indicate VOX is enabled, press **(M)** → **VOX** → **8** until it disappears.

Connect the **EAR** and **MIC** jacks to your TNC as shown below. **MIC** jack impedance is 600 ohms, and maximum input is 300 mV<sub>rms</sub>. **EAR** jack impedance is 8 ohms, and maximum output is 2 V<sub>rms</sub> (w/12-V supply).

**Downloaded by  
RadioAmateur.EU**

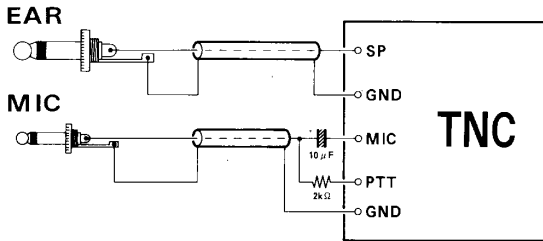





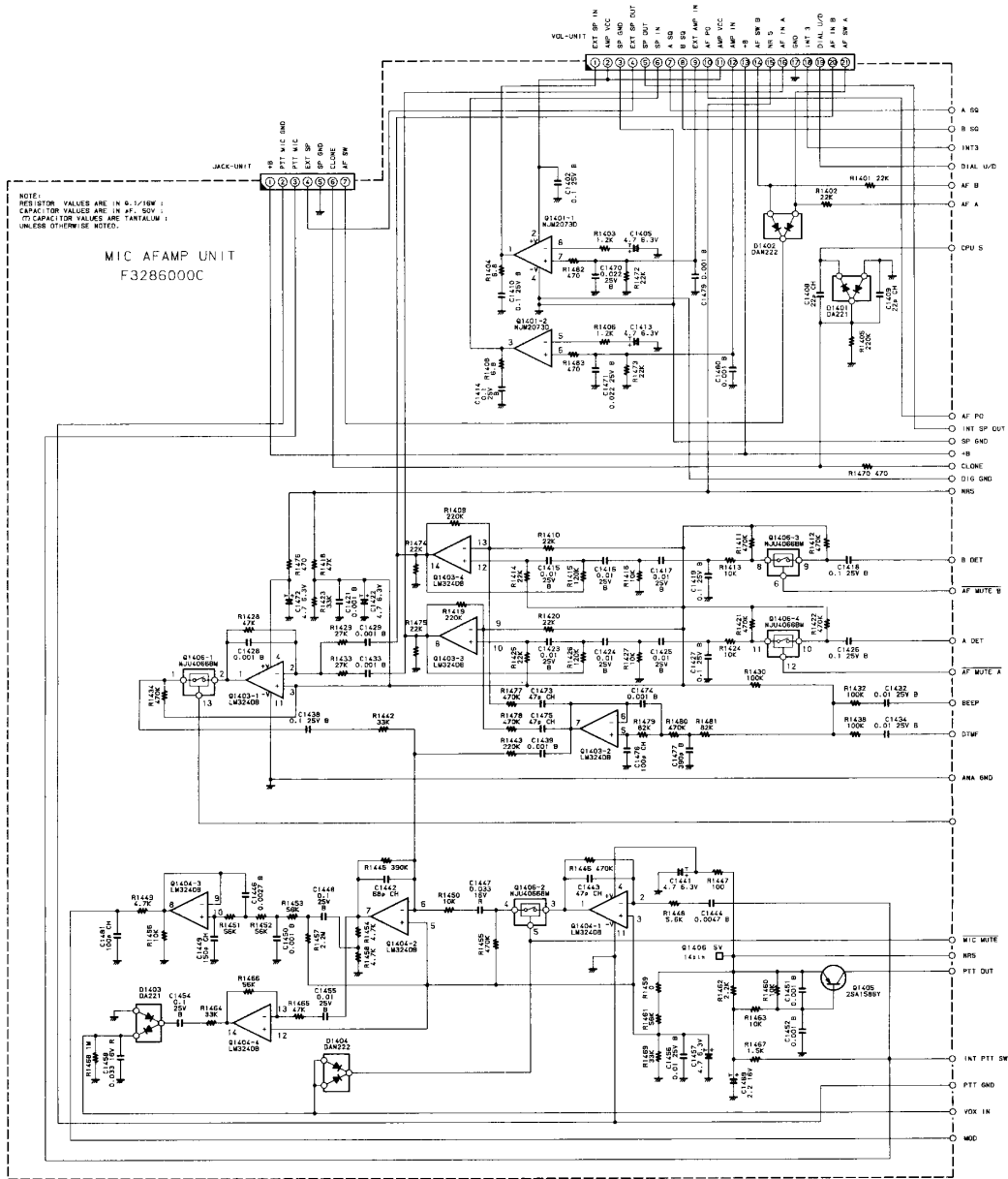

Downloaded by  
RadioAmateur.EU

CNTL UNIT F328600C

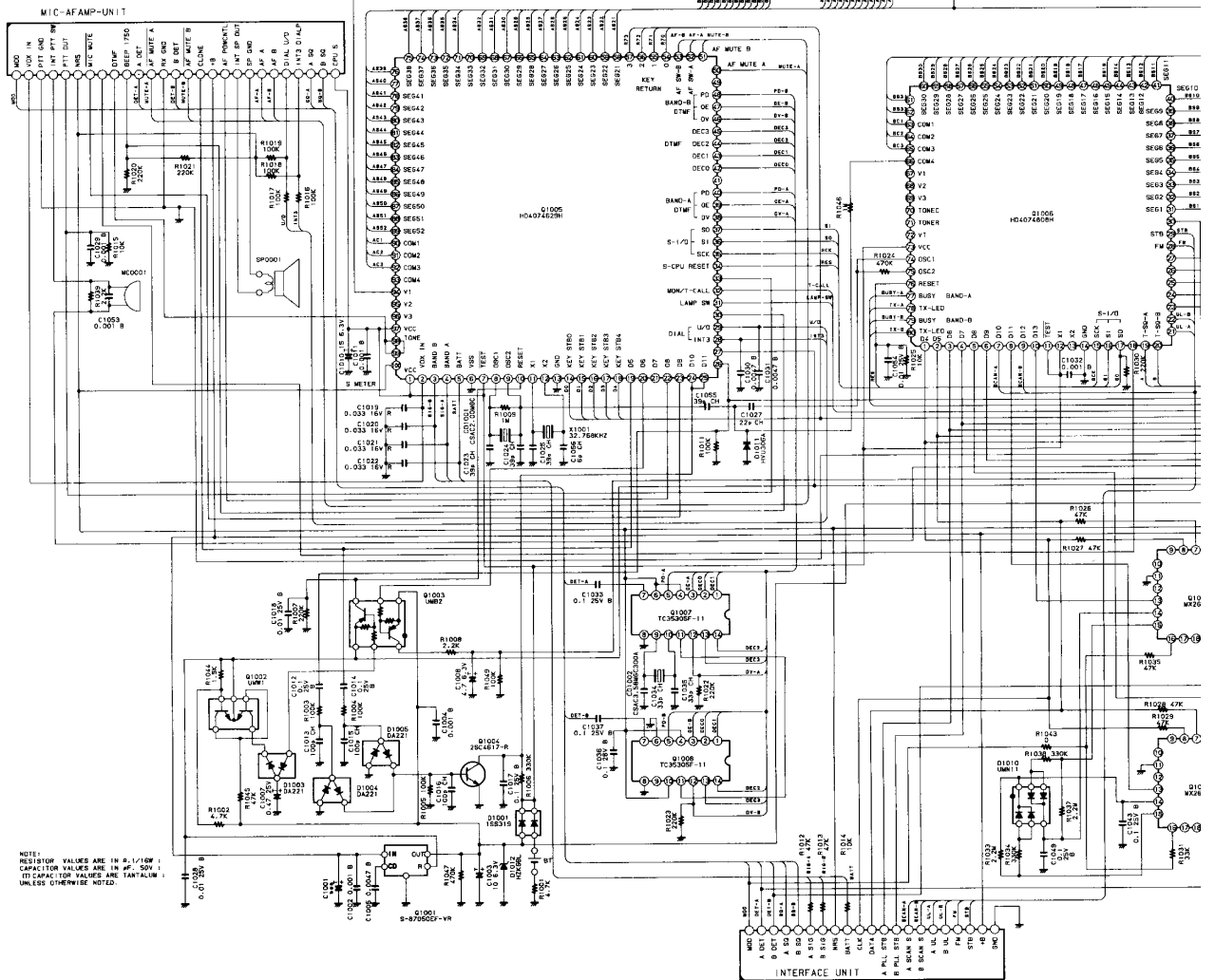



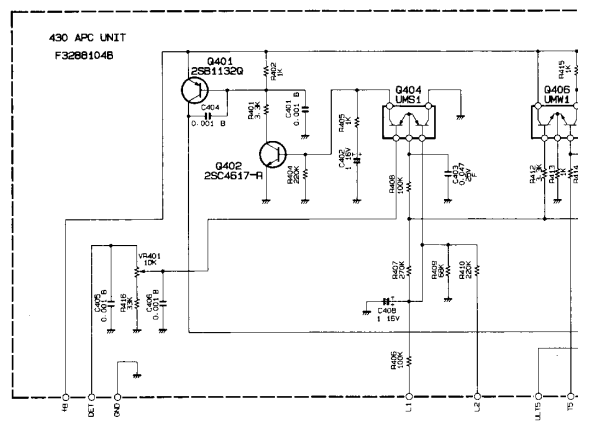
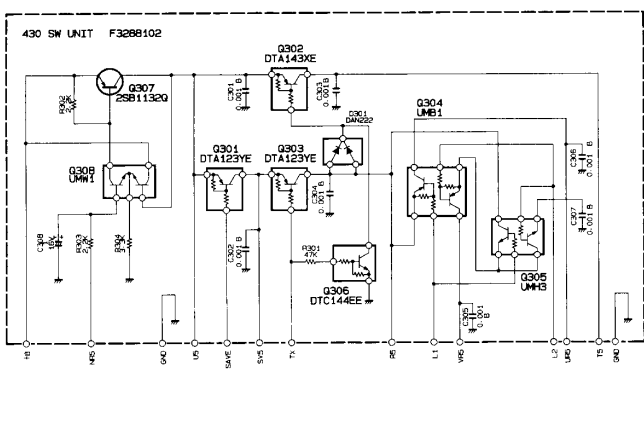
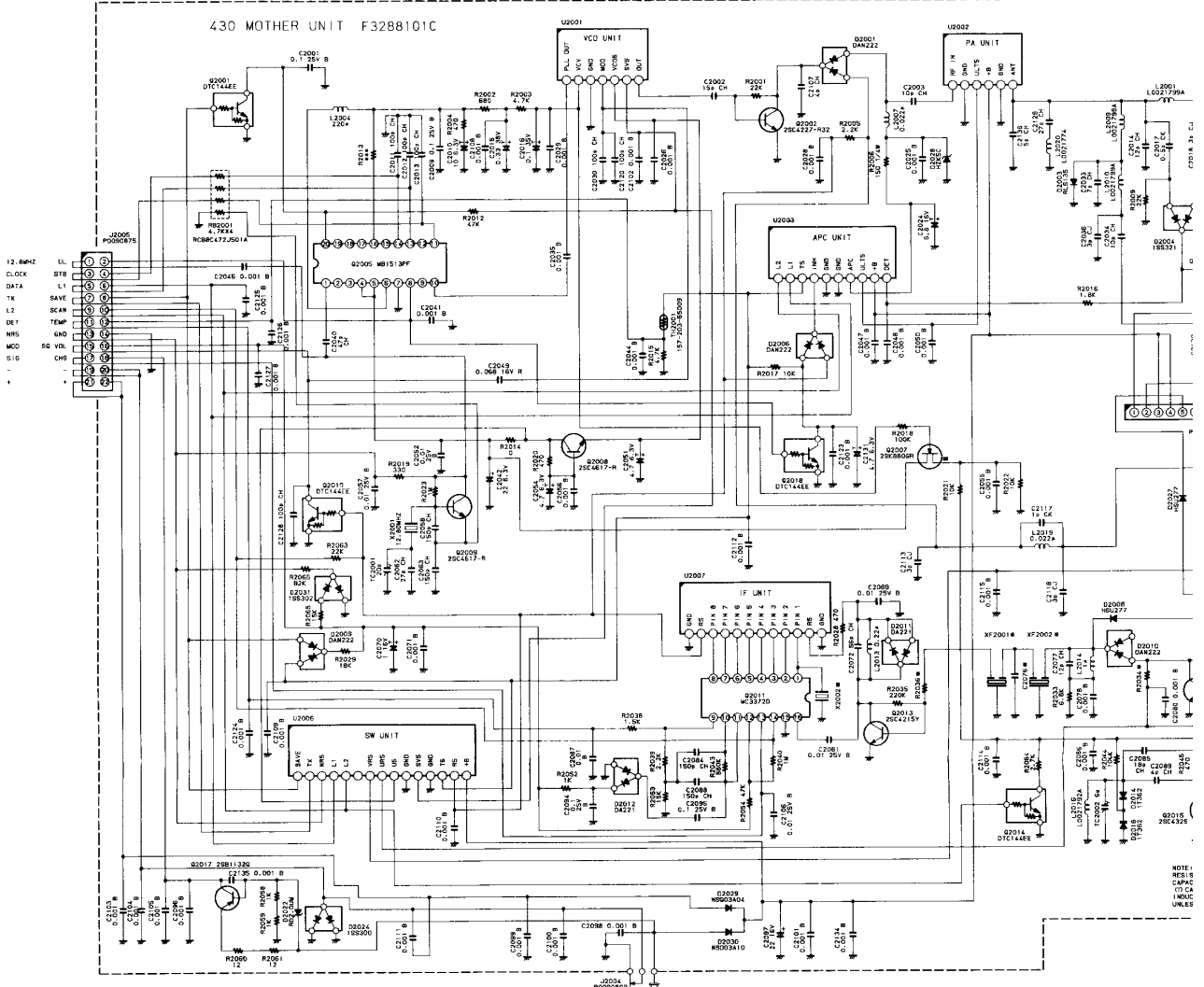

NOTE:  
RES: R  
CAP: C  
IC: IC  
ELECT. PARTS  
UNLESS  
OTHERWISE  
SPECIFIED

